



MULTIMEDIA PROJECTOR

SX80

SX800

User's Manual



Table of Contents

Safety Instructions

Before Use

Projecting an Image

Useful Functions Available During a Presentation

Setting Up Functions from Menus

Projecting an Image from a Digital Camera or an
USB Flash Memory (SX80)

Connecting the Projector to Network (SX80)

Appendix

Index



ENG

Features of SX80/SX800 Multimedia Projector

Thank you for purchasing a Canon projector.

The SX80/SX800 Multimedia Projector (hereinafter referred to as "the projector") is a high-performance projector that is capable of projecting high-resolution computer screens, high-quality digital images (SX80), images from digital cameras and USB flash memories (SX80) on a large screen.

Major Features

Smooth and Beautiful Imaging Capability

Incorporation of AISYS, Canon's unique optical engine, and LCOS (Liquid Crystal On Silicon) achieves high brightness, high contrast ratio, and smooth and beautiful lattice-free images.

Native SXGA+ Resolution

Native SXGA+ resolution (1400 by 1050 dots) ensures projection of a high-quality image in a wider projection area with a high degree of resolution.

High-powered 1.5X Zoom Lens

1.5X zoom aspheric lens can project a 100-inch image when placed 3 m (9.8') to 4.9 m (16.1') away. (P33)

"Auto Setup Function" for Making Setup a Breeze

The keystone distortion is automatically adjusted for quick and easy setup of projector. (P50)

Equipped with HDMI Input Terminal (SX80)

Connecting the projector to AV equipment via HDMI terminal allows you to project high quality digital images. (P42)

Direct Projection of Images Taken by Digital Camera (SX80)

Capable of directly projecting images taken by PictBridge enabled digital cameras. (P108)

Direct Projection of Data on USB Flash Memories (SX80)

Capable of directly projecting JPEG images on USB flash memories. (P112)

"Off and Go" Feature

It can be unplugged and packed away immediately. (P66)

* Wait until the cooling fan stops before putting the projector in the carrying bag.

User-Friendly On-Screen Menu

Settings are organized by four tabs. You can easily find settings for each function. (P74-P106)

Compact and Easy-to-use Wireless Remote Control

It comes with a wireless remote control which allows you to control all functions of this projector. (P24)

User's Manual (this document)

This is a User's Manual for the SX80/SX800 Multimedia Projector. This manual provides detailed information on how to use the projector. Read this manual thoroughly to make the most of your projector and ensure safety.

Important Information and Quick Start Guide

First read document. It provides information about projector safety, cautions, quick start guide*, cleaning and replacing the air filter and lamp replacement.

* This guide shows an outline flowchart of the steps to start and stop the projector, as well as the functions available for projecting images.

Symbols of Button Operations

The projector can be operated using buttons on the remote control or the top control of the projector. The remote control allows you to operate all functions of the projector. In this document, the buttons operation is shown as below.

Top control button operation

Remote control button operation

Symbols Used in This Manual

Meanings of the following symbols used in this manual are as follows:

(SX80): Function or description only applicable to SX80.

(SX800): Function or description only applicable to SX800.

 A precaution about operation or restriction is given here.

Adjusting the Image Size

Use the ZOOM button to adjust the size of the proj
Change the projector installation position if your de
adjust it with the zoom function. (P31)

1 Press the ZOOM button to pop up a window sho

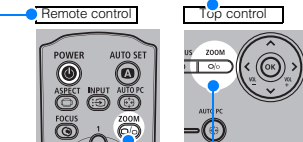

Indicate the buttons to be pressed

COPYRIGHT NOTICE

Please note that enlarging or reducing the size of an image for commercial purposes or public presentation may infringe on the legally protected copyright or the copyright holder of the original material.

About Trademarks

- Microsoft, Windows, Windows XP, Windows Vista and Internet Explorer are registered trademarks or trademarks of Microsoft Corporation in the United States and/or other countries.
- Macintosh and Mac are registered trademarks of Apple Computer, Inc., registered in the United States and/or other countries.
- HDMI, HDMI logo, and High Definition Multimedia Interface are registered trademarks or trademarks of HDMI Licensing, LLC.

Quick Reference Guide

This Quick Reference Guide will help you find functions that make full use of the projector, are useful in producing an attractive presentation, and so on.

Connecting the Projector

Connecting to the Computer (P38 – P41)
Connecting to AV Equipment (P42 – P45)
Connecting a Digital Camera (SX80)
(P46, P108 – P109)
Connecting an USB Flash Memory (SX80)
(P46, P112 – P113)

Projecting an Image

Starting Projection (P47 – P49)
Selecting an Input Signal (P52 – P53)
Projecting an Image from a Digital Camera
(SX80) (P108 – P111)
Projecting Data on USB Flash Memory
(SX80) (P112 – P118)

Adjusting Image

Adjusting the Image Size and Focus
(P56 – P57)
Adjusting Keystone Distortion (P58 – P59)
Adjusting Aspect Ratio (P60 – P64)
Eliminating Flickers from Computer Screen or
Adjusting Positional Shift (P80)

Adjusting Colors and Image Quality

Projecting an Image on a Greenboard (P84)
Selecting an Image Mode Suitable for the
Projecting Image (P89)
Making Fine Color Adjustments (P92, P95)
Removing Noise (P93)

Producing a Presentation

Blackened Out an Image Temporarily (P68)
Freezing the Picture (P68)
Adjusting the Volume (P69)
Muting the Sound (P69)
Zooming an Image (P70)
Showing the Elapsed Time (P71)

Ceiling Mounted Projection or Projecting from behind Screen (P85)

Changing Remote Control Channel (P101)

Resetting Projector Setting

Resetting the Image Settings (P96)
Resetting the Key Lock (P99)
Resetting Password (P102)
Resetting a Network Setting (SX80) (P105)
Resetting to the Default Setting (P105)

Miscellaneous Functions

Reducing the Lamp Brightness (P95)
Using the Power Saving Mode (P97)
Turning on the Projector by Connecting the
Power Cord (P98)
Disabling the Beep During the Operation (P98)
Disabling Buttons (P99)
Hiding Guide Messages (P100)
Turning Off the Projector LED Lamps (P100)
Setting a Password (P102)

Table of Contents

Features of SX80/SX800 Multimedia Projector	2
Quick Reference Guide	4
Safety Instructions	10
Safety Precautions.....	11
■ READ AND KEEP THIS OWNER'S MANUAL FOR LATER USE.....	12
AC Power Cord Requirement.....	14
Federal Communication Commission Notice.....	15
Canadian Radio Interference Regulations.....	15
Precautions on Handling the Batteries in the Remote Controller.....	16
Lamp Handling Precautions.....	16
Carrying/Transporting the Projector.....	17
Installation Precautions.....	17
Before Use	19
Supplied Accessories	20
■ Installing the Lens Cap.....	20
■ Putting the Projector in the Carrying Bag.....	21
Part Names	22
Main Unit of Projector.....	22
■ Front Side.....	22
■ Rear Side.....	22
■ Bottom Side.....	23
Remote Control.....	24
Top Control.....	26
Input Terminals.....	27
■ SX80.....	27
■ SX800.....	27
Preparing the Remote Control	29
■ Installing Remote Control Batteries.....	29
■ Remote Control Operating Range.....	29
Projecting an Image	31
Steps for Setting Up the Projector and Projecting an Image	32
Setting Up the Projector	33
■ Placing in Front of the Screen.....	33
■ Placing on a Level Place.....	34
■ When Pointing the Projector Up.....	35
Connecting the Projector	36
Connectable Equipment and Input Terminals.....	36
■ SX80.....	36
■ SX800.....	37
Connecting the Projector to the Computer.....	38
■ Connecting to RGB Monitor Output Terminal (analog connection).....	38
■ Connecting to DVI Monitor Output Terminal (digital connection) (SX80).....	40
■ Outputting an Image and Audio.....	40
Connecting to AV Equipment.....	42
■ Connecting to Digital Video Output Terminal (digital connection) (SX80).....	42
■ Connecting to Analog Video Output Terminal (analog connection).....	43

- Outputting Audio to Speakers..... 45
 - Connecting a Digital Camera or an USB Flash Memory (SX80)..... 46
- Starting Projection 47**
 - When the Language Selection Screen Appears..... 48
 - When the Password Input Screen Appears..... 49
 - When "No signal" Appears..... 49
 - When Notebook Computer Screen Does Not Appear 49
 - Adjusting Image..... 49
- Changing Notebook Computer Screen Output..... 49**
 - Turning On External Monitor Output 49
- Setting Up the Screen Automatically 50**
 - Auto Setup..... 50
 - Performing the Auto Setup..... 51
- Selecting an Input Signal (INPUT) 52**
 - Types of Input Signals 52
 - Selecting an Input Signal..... 53
- Adjusting Image 54**
 - Setting the Display Resolution of the Computer..... 54
 - Windows Vista 54
 - Windows XP 54
 - Macintosh OSX 54
 - AUTO PC 55
 - Performing the Auto PC Function..... 55
 - Adjusting the Image Size..... 56
 - Adjusting the Focus..... 57
 - Auto focusing (SX80)..... 57
 - Manual focusing..... 57
 - Adjusting Keystone Distortion 58
 - Auto adjustment..... 58
 - Manual adjustment..... 58
 - Resetting the Keystone Adjustment..... 59
- Selecting Screen Aspect and Aspect..... 60**
 - Selecting Screen Aspect 60
 - Moving Image with 16:9 D. Image Shift 62
 - Resetting the Image Shift..... 62
 - Selecting Aspect Ratio 63
 - Types of Aspect Ratios..... 63
 - How to Select an Aspect Ratio 64
- Selecting an Image Mode 65**
 - Image modes 65
 - How to Select an Image Mode..... 65
- Turning Off the Projector 66**
- Useful Functions Available During a Presentation 67**
 - Useful Functions Available During a Presentation..... 68**
 - Blackened Out an Image Temporarily..... 68
 - Freezing the Picture 68
 - Adjusting the Volume 69

Muting the Sound.....	69
Zooming an Image.....	70
Showing the Elapsed Time	71
Projecting Image Without Computer (SX80).....	71
Setting Functions from Menus.....	73
How to Use Menu	74
■ Menu Configuration	74
■ Basic Operation of Menu.....	75
Setting Display Status	77
Selecting an Image Projection Mode	77
Selecting an Input Signal Type (ANALOG PC).....	78
Selecting an Input Signal Type (VIDEO/S-VIDEO).....	78
Selecting an Input Signal Type (COMPONENT)	79
Adjusting Input Signal (ANALOG PC) – Total Dots	79
Adjusting Input Signal (ANALOG PC) – Tracking	80
Adjust Input Signal (ANALOG PC) – Horizontal position	80
Adjust Input Signal (ANALOG PC) – Vertical position	81
Adjust Input Signal (ANALOG PC) – Horizontal pixels	81
Adjust Input Signal (ANALOG PC) – Vertical pixels	82
Selecting HDMI Input Level (SX80)	82
Select HDMI Over Scan (SX80)	83
Performing Progressive Processing	83
Selecting a Menu Position	84
Correcting the Screen Color	84
Reversing projection	85
Capturing a Logo	86
Selecting the User Logo Display Position.....	86
No Signal Screen.....	87
Screen When Blank	87
Selecting a Logo at Startup	88
Selecting Aspect Ratio of Screen	88
Setting the Image Quality	89
Selecting an Image Quality.....	89
Adjusting the Brightness	90
Adjusting the Contrast	90
Adjusting the Sharpness.....	91
Making a Gamma Correction.....	91
Making Color Adjustment (HDMI/Digital PC/Analog PC/USB).....	92
Making Color Adjustment (COMPONENT/VIDEO/S-VIDEO).....	92
Making Advanced Adjustment (Noise reduction)	93
Making Advanced Adjustment (Dynamic gamma)	93
Making Advanced Adjustment (Mem. color correct) (SX80).....	94

Making Advanced Adjustment (Auto fleshtone) (SX80)	94
Adjusting Fine Color Adjustment (6-axis color adjust) (SX80)	95
Reducing the Lamp Brightness	95
Resetting the Image Settings	96
Setting Various Function.....	97
Setting Auto Setup Function.....	97
Selecting the Power Management Mode	97
Skip the POWER Button Operation.....	98
Enabling/Disabling the Beep	98
Prohibiting the Projector Operation	99
Selecting a Display Language.....	99
Showing/hiding the Guide Screen	100
Turning on/off LED Illumination.....	100
Setting for Slideshow (SX80)	101
Setting up the Remote Control Channel	101
Extending the Menu Display Time.....	102
Setting a Password	102
Registering a Password	103
Resetting the Lamp Counter	103
■ About the Display of the Lamp Counter.....	104
Initializing network settings (SX80)	105
Resetting to the Default Setting.....	105
Checking the Information of the Projector	106
Projecting an Image from a Digital Camera or an USB Flash Memory (SX80)	107
Projecting an Image from a Digital Camera (SX80).....	108
Connecting a Digital Camera	108
Operating the Projected Image	110
■ Switching to the Next Image.....	110
■ Rotating an Image.....	110
Running a Slideshow.....	111
■ Setting a Slideshow Interval.....	111
■ Finishing projection.....	111
Projecting Data on USB Flash Memory (SX80)	112
Connecting an USB Flash Memory.....	112
Description of USB File Browser.....	114
Selecting an Image for Projection	115
■ Selecting a Drive.....	115
■ Selecting a Folder.....	115
■ Selecting an Image File for Projection	116
Operating the Projected Image	117
■ Switching to the Previous/Next Image.....	117
■ Rotating an Image.....	117
■ Returning to the USB File Browser.....	117

Running a Slideshow of Data saved in a USB Flash Memory	118
■ Creating an Image File Folder	118
■ Setting a Slideshow Interval	118
Connecting the Projector to Network (SX80).....	119
Setting an IP Address (SX80)	120
■ Setting IP Address of the Computer	120
■ Resetting the IP Address Setting of the Computer	121
■ Setting the Error Notification Message	121
■ If You Want to Reset the Network Setting	123
■ Error Notification Message	123
Appendix	125
Troubleshooting	126
WARNING Lamp Flash Patterns	126
Symptoms and Solutions	127
■ You cannot turn on the projector.	127
■ You cannot project an image from the projector.	127
■ A digital camera or USB flash memory is not recognized. (SX80).....	128
■ You cannot hear sound.	128
■ The projected image is blur.....	129
■ You cannot project an image appropriately.	129
■ The projector is forced to be turned off.	129
■ You cannot operate the remote control.	130
Maintenance.....	131
Cleaning the Projector	131
Cleaning and Replacing the Air Filter	132
■ Cleaning the Air Filter	132
■ Replacing the Air Filter	132
Replacing the Lamp.....	133
■ About the Replacing Lamp.....	133
■ Replacing the Lamp	134
Relationship between Aspect and Screen Aspect	135
When Projecting an Image from a Computer	135
When Projecting an Image from Image Software	136
When Projecting an Image from a Digital Camera or a USB Flash Memory (SX80).....	137
Supported Computer Signal Types	138
Relationship between Screen Size and Projecting Distance	139
Glossary	140
Specifications	144
■ Projector	144
■ Remote Control.....	144
■ External View	145
■ ANALOG PC-1 (SX800), ANALOG PC-2/COMPONENT IN terminal.....	145
■ Service Port (CONTROL).....	146
Index	147
Menu Configuration	152





Safety Instructions

Before operating this projector, read this manual thoroughly in order to operate the projector properly.

This projector offers many convenient features and functions. Operating the projector properly enables you to manage those features and maintain it in good condition for a long period.

Improper operation may result in not only reducing the product-life, but also malfunctions, fire hazards, or other accidents.

If your projector is not operating correctly, read this manual again, check operations and cable connections, and try the solutions shown in the "Troubleshooting" section at the end of this booklet. If the problem still persists, contact the service center or the dealer where you purchased the projector.

	CAUTION RISK OF ELECTRIC SHOCK DO NOT OPEN	
CAUTION: TO REDUCE THE RISK OF ELECTRIC SHOCK, DO NOT REMOVE COVER (OR BACK). THERE ARE NO USER-SERVICEABLE PARTS INSIDE EXCEPT LAMPS. REFER SERVICING TO QUALIFIED SERVICE PERSONNEL.		
	THIS SYMBOL INDICATES THAT DANGEROUS VOLTAGE CONSTITUTING A RISK OF ELECTRIC SHOCK IS PRESENT WITHIN THIS UNIT.	
	THIS SYMBOL INDICATES THAT THERE ARE IMPORTANT OPERATING AND MAINTENANCE INSTRUCTIONS FOR THIS UNIT IN THE OWNER'S MANUAL.	

CAUTION Not for use in a computer room as defined in the Standard for the Protection of Electronic Computer/Data Processing Equipment, ANSI/NFPA 75.
--

Safety Precautions

WARNING: TO REDUCE THE RISK OF FIRE OR ELECTRIC SHOCK, DO NOT EXPOSE THIS APPLIANCE TO RAIN OR MOISTURE.

- This projector projects intense light from the projection lens. Do not stare directly into the lens if possible, as doing so may result in eye damage. Be especially careful that children do not stare directly into the beam.
- Install the projector in an appropriate position. Installing the projector in an inappropriate position may result in a fire hazard.
- Allow for appropriate space above, beside and behind of the projector cabinet for allowing air circulation and cooling of the projector. Minimum clearances must be maintained. If the projector is to be built into a compartment or similarly space, the minimum distances must be maintained. Do not cover the ventilation slot on the projector. Heat build-up can reduce the service life of your projector, and can also be dangerous.

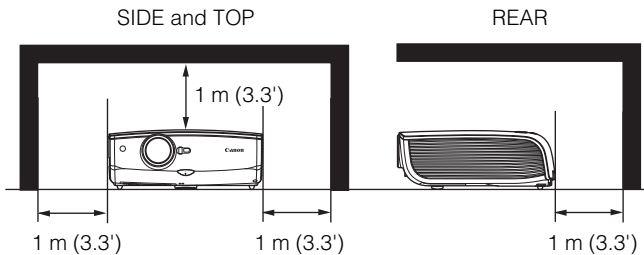

- Do not put any flammable objects or spray cans near the projector, as the hot air exhausted from the ventilation holes may result in an explosion.
- If the projector is not to be used for an extended period of time, unplug it from the power outlet.

■ **READ AND KEEP THIS OWNER'S MANUAL FOR LATER USE.**

All the safety and operating instructions should be read before beginning to operate the product.

Read all of the instructions given here and retain them for later use. Unplug this projector from the AC power supply before cleaning. Do not use liquid or aerosol cleaners on the projector. Use a damp cloth for cleaning.

Follow all warnings and instructions marked on the projector.

For added protection of the projector during a lightning storm, or when it is left unattended or unused for long periods of time, unplug it from the wall outlet. This will prevent damage due to lightning and power surges.

Do not expose this unit to rain or use near water... for example, in a wet basement, near a swimming pool, etc...

Do not use attachments not recommended by the manufacturer as they may result in hazards.

Do not place this projector on an unstable cart, stand, or table. The projector may fall, causing serious injury to a child or adult, and serious damage to the projector. Use only with a cart or stand recommended by the manufacturer, or sold with the projector. Wall or shelf mounting should be carried out in accordance with the manufacturer's directions, and should use a mounting kit approved by the manufacturers.

An appliance and cart combination should be moved with care.

Sudden stops, excessive force, and uneven surfaces may cause the appliance and cart combination to overturn.



Slots and openings in the back and bottom of the cabinet are provided for ventilation, to insure reliable operation of the equipment and to protect it from overheating.

The openings should never be covered with cloth or other materials, and the bottom opening should not be blocked by placing the projector on a bed, sofa, rug, or other similar surface. This projector should never be placed near or over a radiator or heat register.

This projector should not be placed in a built-in installation such as a book case unless proper ventilation is provided.

Never push objects of any kind into this projector through cabinet slots as they may touch dangerous voltage points or short out parts that could result in a fire or electric shock. Never spill liquid of any kind onto the projector.

Do not install the projector near the ventilation duct of air-conditioning equipment.

This projector should be operated using only the type of power source indicated on the marking label. If you are not sure of the type of power supplied, consult your authorized dealer or local power company.

Do not overload wall outlets and extension cords as this can result in fire or electric shock. Do not allow anything to rest on the power cord. Do not locate this projector where the cord may be damaged by people walking on it.

Do not attempt to service this projector yourself as opening or removing covers may expose you to dangerous voltages or other hazards. Refer all servicing to qualified service personnel.

Unplug this projector from the wall outlet and refer servicing to qualified service personnel under the following conditions:

- a. When the power cord or plug is damaged or frayed.
- b. If liquid has been spilled into the projector.
- c. If the projector has been exposed to rain or water.
- d. If the projector does not operate normally after following the operating instructions. Adjust only those controls that are covered in the operating instructions as improper adjustment of other controls may result in damage and will often require extensive work by a qualified technician to restore the projector to normal operating condition.
- e. If the projector has been dropped or the cabinet has been damaged.
- f. When the projector exhibits a distinct change in performance-this indicates a need for servicing.

When replacement parts are required, be sure the service technician uses replacement parts specified by the manufacturer that have the same characteristics as the original parts. Unauthorized substitutions may result in fire, electric shock, or injury.

Upon completion of any service or repairs to this projector, ask the service technician to perform routine safety checks to determine that the projector is in safe operating condition.

AC Power Cord Requirement

The AC Power Cord supplied with this projector meets the requirements for use in the country you purchased it.

AC Power Cord for the United States and Canada:

The AC Power Cord used in the United States and Canada is listed by the Underwriters Laboratories (UL) and certified by the Canadian Standard Association (CSA).

The AC Power Cord has a grounding-type AC line plug. This is a safety feature to ensure the plug fits into the power outlet. Do not try to tamper with this safety feature. Should you be unable to insert the plug into the outlet, contact your electrician.

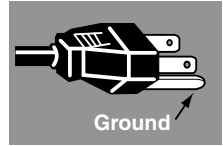

THE SOCKET-OUTLET SHOULD BE INSTALLED NEAR THE EQUIPMENT AND EASILY ACCESSIBLE.

NOTE FOR CUSTOMERS IN THE US

(Hg) LAMP(S) INSIDE THIS PRODUCT CONTAIN MERCURY AND MUST BE RECYCLED OR DISPOSED OF ACCORDING TO LOCAL, STATE OR FEDERAL LAWS.



European Union (and EEA) only.

These symbols indicate that this product is not to be disposed of with your household waste, according to the WEEE Directive (2002/96/EC), the Battery Directive (2006/66/EC) and/or your national laws implementing those Directives. If a chemical symbol is printed beneath the symbol shown above, in accordance with the Battery Directive, this indicates that a heavy metal (Hg = Mercury, Cd = Cadmium, Pb = Lead) is present in this battery or accumulator at a concentration above an applicable threshold specified in the Battery Directive. This product should be handed over to a designated collection point, e.g., on an authorized one-for-one basis when you buy a new similar product or to an authorized collection site for recycling waste electrical and electronic equipment (EEE) and batteries and accumulators. Improper handling of this type of waste could have a possible impact on the environment and human health due to potentially hazardous substances that are generally associated with EEE. Your cooperation in the correct disposal of this product will contribute to the effective usage of natural resources. For more information about the recycling of this product, please contact your local city office, waste authority, approved scheme or your household waste disposal service or visit www.canon-europe.com/environment.



(EEA: Norway, Iceland and Liechtenstein)

Federal Communication Commission Notice

Multimedia Projector, Model: SX80/SX800

This device complies with Part 15 of the FCC Rules. Operation is subject to the following two conditions:

- (1) This device may not cause harmful interference, and
- (2) this device must accept any interference received, including interference that may cause undesired operation.

Note: This equipment has been tested and found to comply with the limits for a Class B digital device, pursuant to Part 15 of the FCC Rules. These limits are designed to provide reasonable protection against harmful interference in a residential installation. This equipment generates, uses and can radiate radio frequency energy and, if not installed and used in accordance with the instructions, may cause harmful interference to radio communications. However, there is no guarantee that interference will not occur in a particular installation. If this equipment does cause harmful interference to radio or television reception, which can be determined by turning the equipment off and on, the user is encouraged to try to correct the interference by one or more of the following measures:

- Reorient or relocate the receiving antenna.
- Increase the separation between the equipment and receiver.
- Connect the equipment into an outlet on a circuit different from that to which the receiver is connected.
- Consult the dealer or an experienced radio/TV technician for help.

The cable with a ferrite core provided with the projector must be used with this equipment in order to comply with Class B limits in Subpart B of Part 15 of the FCC rules.

Use of a shielded cable is required to comply with class B limits in Subpart B of Part 15 of FCC Rules.

Do not make any changes or modifications to the equipment unless otherwise specified in the instructions. If such changes or modifications should be made, you could be required to stop operation of the equipment.

Canon U.S.A., Inc.

One Canon Plaza, Lake Success, NY 11042, U.S.A.

Tel No. (516) 328-5600

Canadian Radio Interference Regulations

This Class B digital apparatus complies with Canadian ICES-003.

Precautions on Handling the Batteries in the Remote Controller



Observe the following precautions when handling the batteries. Failure to do so may cause explosion, heat generation, fire, or leakage of the battery fluid.

- Do not heat or disassemble the batteries, or throw them into fire.
- Do not attempt to recharge the batteries.



Observe the following precautions when handling the batteries. Failure to do so may cause explosion, heat generation, fire or leakage of the battery fluid.

- Remove the batteries when they have been exhausted or not in use for an extended period of time.
- Be sure to replace both batteries at the same time. Do not mix batteries of different types.
- Insert batteries correctly according to the "+" and "-" markings.
- If a fluid from a battery leaks and comes in contact with your skin, rinse the affected skin thoroughly as soon as possible.

Lamp Handling Precautions

This projector uses a high-pressure mercury lamp which must be handled carefully and correctly as mentioned below.

The mercury lamp has the following characteristics.

- A lamp may explode with a loud sound or burn out due to a shock, scratch, or use beyond its expiry date.
- The lamp life may differ from lamp to lamp and according to the usage environment. There is no guarantee that all lamps will last for the same period of time. Some lamps may fail in a shorter period of time than other similar lamps.
- A lamp gradually becomes darker over time.



If a Lamp Explodes

- If a lamp explodes, gas or dust may come out of the exhaust vent. Open windows and doors for ventilation.
- The gas contains toxic mercury. Always keep your face away from the exhaust vent when the projector is operating to avoid inhaling mercury vapors or to prevent it from getting in your eyes or mouth.
- If you inhale the gas or the shards of the broken lamp contact your eyes or mouth, consult a doctor immediately.
- If a lamp explodes, its shards may scatter inside the projector. Ask the Canon service representative to clean and check the inside of the projector and replace the lamp.



If the projector indicates that the lamp should be replaced (i.e., the LAMP REPLACE indicator lights up twice),

- The chances of an explosion increase. Replace the lamp with a new one immediately if such is the case.



Disposal of Waste Lamp

- Dispose of the projector's mercury lamp according to local regulations just like the fluorescent lamps.

Carrying/Transporting the Projector



- This projector is a precision machine. Do not subject the projector to strong shocks or vibrations or turn it down.
- Install the lens cap to protect the lens and put the projector in the carrying bag to protect it from dust and scratches on the surface of it when you carry the projector. For details, see [P21](#).
- Wait until the cooling fan stops before putting the projector in the carrying bag. Do not put the projector in the carrying bag until the cooling fan stops rotating. The projector may be damaged due to the heat.
- Replace the adjustable foot before putting the projector in the carrying bag. The projector may be damaged if you put it in the bag without replacing the adjustable foot.
- The carrying bag is not designed to protect the projector from external shocks. When carrying the projector with it put in the carrying bag, do not give a shock to it, drop it, or place anything on it. The projector may be damaged or malfunctioned.
- Do not transport the projector through a courier or transport service with the carrying bag. Put the projector in an impact-resistant transport case if such is the case.

Installation Precautions



The area around the exhaust vent and the cabinet above the exhaust vent become hot when the projector is operating.

- Do not touch these areas, or you may get burnt. In particular, keep children away from these areas. Do not put anything that may deform or discolor due to heat on the projector.

Hot air is exhausted from the exhaust vent. Observe the following:

- Do not put any metallic object on the projector. It may become hot, resulting in accident or injury.
- Do not seat anyone near the exhaust vent. Otherwise, you may get burned.

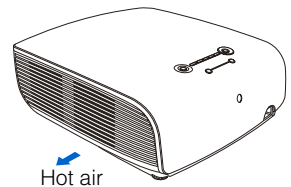

When placing the projector on a castered stand or table, be sure to lock the casters.

- Failure to do so may cause the projector to move or topple, resulting in an injury.



Position the projector in a horizontal position. Incorrect installation may cause troubles and accidents.

- Do not tilt the projector more than 20 degrees above and below the horizontal.
- When you want to use your projector pointing up or down, make sure to place the projector straight up or down.

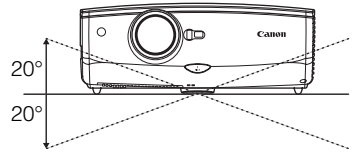

Do Not Use in the Following Environments

- Do not place the projector on an unstable or slanted surface. The projector may fall causing a personal injury.
- Do not place it in an oily, smoky, or damp location (e.g., near a cooking table or a humidifier). It may cause a fire or an electric shock.
- Place the projector with a minimum distance of 1 m (3.3') from its left, right, rear, and top panels to the neighboring object such as a wall. Otherwise, it may damage the projector due to bad exhaust ventilation.
- Do not put anything near the exhaust vent that may deform or deteriorate due to heat.
- Do not install the projector in a humid or dusty location or a position where there is a lot of oily or cigarette smoke. Optical parts such as a lens and mirror may be stained, resulting in poor picture quality.
- Do not place it near an exhaust outlet of air-conditioning equipment. Otherwise, it may be damaged.

If the projector is carried from a cold place to a warm place or the room temperature is raised rapidly, condensation may form on the lens and mirror due to the moisture in the atmosphere, resulting in a blurred picture. Wait until condensation evaporates and normal picture is shown.

Do not use the projector in a place subject to either very high or very low temperatures. Doing so may cause malfunction. The ranges of the operating and storage temperatures are as shown below:

Operating temperature: +5°C to +35°C (Humidity: 85% or below)

Storage temperature: -10°C to +60°C (Humidity: 90% or below)

Using the Projector at 2300 Meters or More Above Sea Level

- If you use the projector at 2300 meters or more above sea level, the special configuration is required to cool down the projector properly. Contact your dealer.

Before Use

Table of Contents

Safety Instructions

Before Use

Projecting an Image

Useful Functions Available During a Presentation

Setting Up Functions from Menus

Projecting an Image from a Digital Camera or an
USB Flash Memory (SX80)

Connecting the Projector to Network (SX80)

Appendix

Index

Supplied Accessories

Check whether the following accessories are supplied with the projector.

- Remote control

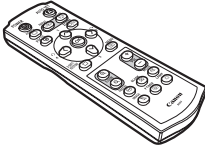

- Batteries (type AAA, two) for remote control

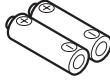

- Computer connection cable (DVI/Mini D-sub, 15-pin) (1.8 m/5.9') (SX80)

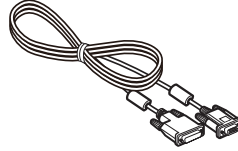

- Power cord (2 m/6.6')

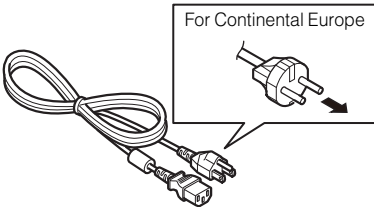

For the U.S.A and Canada

- Component cable (RCA/Mini D-sub, 15-pin) (0.4 m/1.3')

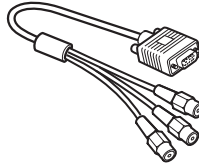

- Computer connection cable (VGA/Mini D-sub, 15-pin) (1.8 m/5.9') (SX800)

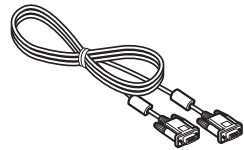

- Lens cap



- Lens cap strap

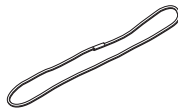

- Carrying bag

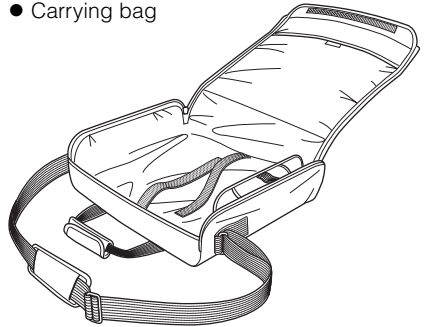

- User's Manual (CD-ROM)
- Warranty card
- Important Information and Quick Start Guide

■ Installing the Lens Cap

As shown in the illustration on the right, put the lens cap strap through the hole on the lens cap, and then through the lens cap strap insertion hole at the bottom of the projector.

- When the projector is not in use, attach the lens cap to protect the lens.

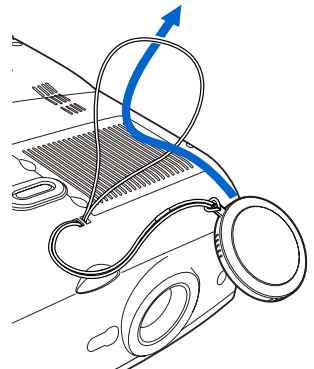

■ Putting the Projector in the Carrying Bag

Store the projector and the accessories in the carrying bag as shown in the illustration below.

The carrying bag is intended to protect the surfaces of the projector from dust or scratches, and is not designed to protect the projector from external shocks.

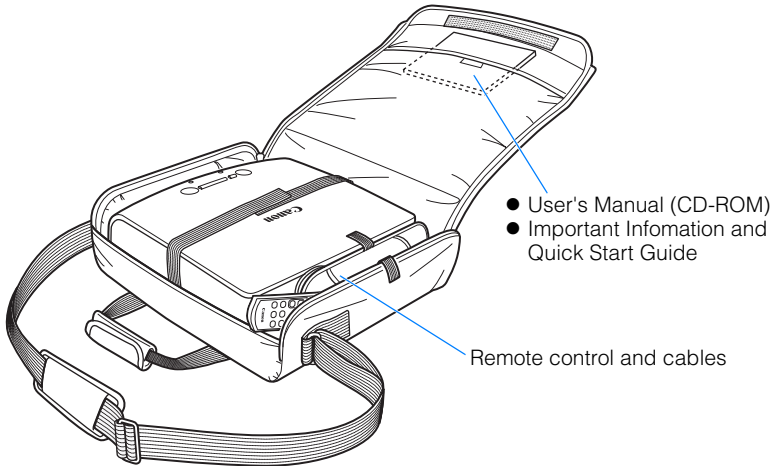

- Wait until the cooling fan stops before putting the projector in the carrying bag. Do not put the projector in the carrying bag until the cooling fan stops rotating. The projector may be damaged due to the heat.
- Attach the lens cap to the lens to protect it and put the projector in the carrying bag. Replace the adjustable foot to prevent the damage on the projector.
- When carrying the projector with it put in the carrying bag, do not give a shock to it, drop it, or place anything on it. The projector may be damaged or malfunctioned.

Part Names

Main Unit of Projector (SX80 is used in the following illustrations)

■ Front Side

Anti-theft lock hole
An anti-theft wire cable available on the market can be connected.

Caution
Be sure to remove the lens cap during projection. Failure to do so will result in fire hazards or cap deformation.

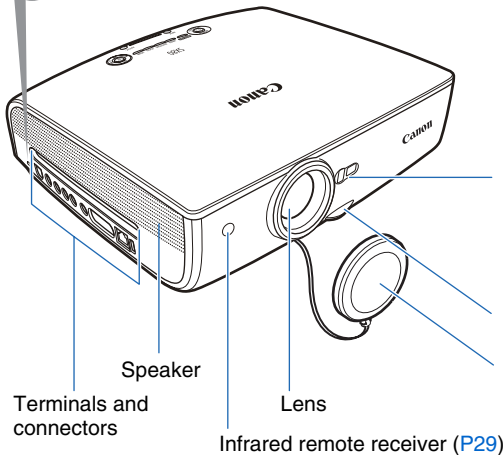



Ranging window (SX80)
Do not place any obstacle between the projector and the screen, as the auto focusing function may fail to operate correctly.

Adjustable foot lock button (P35)

Lens cap (P20)

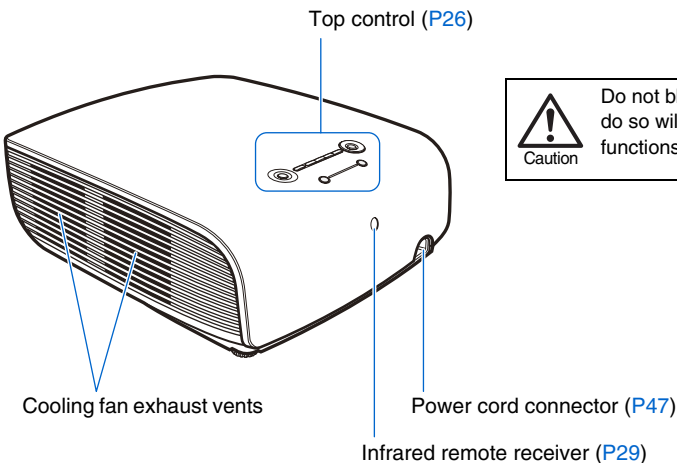
■ Rear Side



Caution
Do not block the air exhaust. Failure to do so will result in fire hazards or malfunctions.

Bottom Side

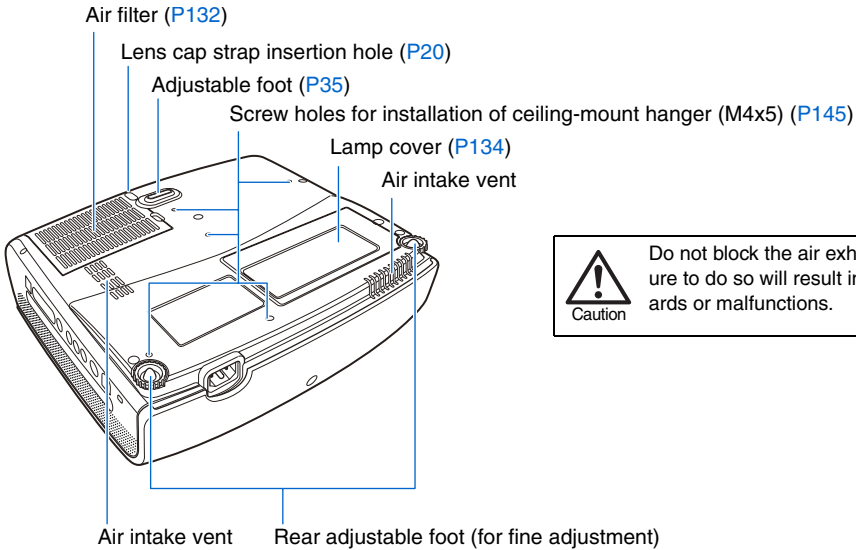

Caution

Do not block the air exhaust. Failure to do so will result in fire hazards or malfunctions.

Before Use

Mounting the Projector on the Ceiling

You can mount the projector on the ceiling. You need an optional ceiling mounting hanger (part number: RS-CL10) and an optional ceiling-mount pipe (part number: RS-CL08 or RS-CL09) when appropriate. Contact the dealer where you purchased the projector for more detailed information.



- Make sure to use the optional ceiling-mount hanger.
- You should never install the ceiling-mount hanger by yourself.
- If you mount the projector on the ceiling, you have to invert the projected image by selecting [Image flip H/V] from the menu. (P85)

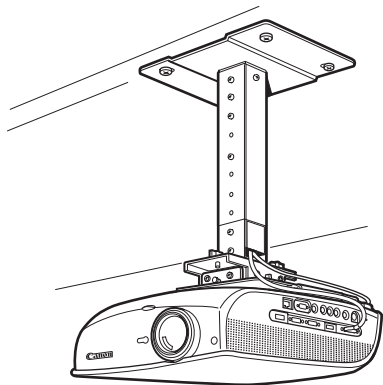

Remote Control

The projector can be operated using buttons on the remote control or the top control on the main unit.

The remote control allows you to operate all functions of the projector.

POWER button (P47, P66)

Turns the projector on or off.

ASPECT button (P64)

Toggles between the modes for aspect ratio.

FOCUS button (P57)

Adjusts focusing.

[^] [v]: For rough adjustment.

[<] [>]: For fine adjustment.

In SX80, press **FOCUS** and then **AUTO SET** to adjust the focus automatically.

D.SHIFT/KEystone button (P58)

Corrects keystone distortion.

[^] [v]: For keystone adjustment.

Press **D.SHIFT/KEystone** and then **AUTO SET** to adjust the keystone automatically.

- Moves the image up and down when the

D. image shift is selected. (P62)

- [^] [v]: Adjust the vertical position.

D. ZOOM button (P70)

Zooms the image in or out digitally.

[+]: Zooms the image in (up to 12x).

[-]: Zooms the image out (1x minimum).

[^] [v] [<] [>]: Moves an image to the desired position.

FREEZE button (P68)

Freezes the projected image.

IMAGE button (P65)

Switches among image modes (image qualities).

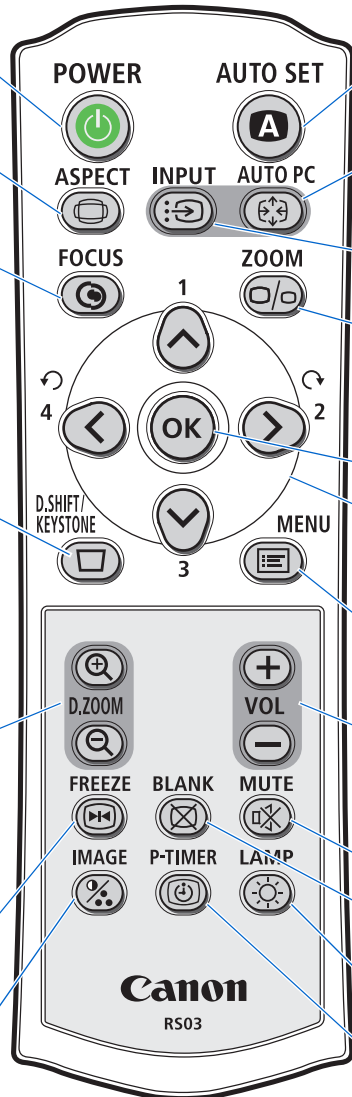

AUTO SET button (P51)

Performs input signal setting, keystone distortion adjustment, focusing (SX80), and screen color correction (SX80) automatically.

INPUT button (P53)

Switches among input signals.

ZOOM button (P56)

Adjusts the image size.

[^] [v]: For rough adjustment.

[<] [>]: For fine adjustment.

Pointer buttons (P75)

Selects the upper, lower, left or right item in the menu.

MENU button (P74)

Displays a menu on the screen.

VOL button (P69)

Adjusts the sound volume.

[+]: Increases the volume.

[-]: Decreases the volume.

BLANK button (P68)

Toggles between display/non-display of image.

P-TIMER button (P71)

Displays the time elapsed since this button was pressed.

AUTO PC button (P55)

Adjusts tracking and so on automatically in accordance with signal from a computer when ANALOG PC-1 or ANALOG PC-2 is selected.

OK button (P76)

Determines the item selected from the menu.

MUTE button (P69)

Mutes the sound.

LAMP button (P95)

Switches the lamp mode between Standard and Silent.

Top Control

KEYSTONE button (P58)

Corrects keystone distortion. (P58)
 [^] [v]: For keystone adjustment.
 Press **KEYSTONE** and then **AUTO SET** to adjust the keystone automatically.

- Moves the image up and down when the D. image shift is selected. (P62)
- [^] [v]: Adjust the vertical position.

MENU button (P74)

Displays a menu on the screen.

AUTO SET button (P51)

Performs input signal setting, keystone distortion adjustment, focusing (SX80), and screen color correction (SX80) automatically.

FOCUS button (P57)

Adjusts focusing.
 [^] [v]: For rough adjustment.
 [<] [>]: For fine adjustment.
 In SX80, press **FOCUS** and then **AUTO SET** to adjust the focus automatically.

ZOOM button (P56)

Adjusts the image size.
 [^] [v]: For rough adjustment.
 [<] [>]: For fine adjustment.

OK button (P76)

Determines the item selected from the menu.

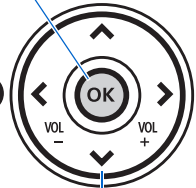
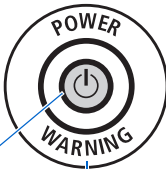

INPUT



AUTO PC



INPUT button (P53)

Switches among input signals.

Pointer/VOL button (P75, P69)

Adjusts the sound volume.
 [<]: Decreases the volume.
 [>]: Increases the volume.
 Selects the upper, lower, left or right item in the menu.

WARNING lamp (P126)

Flashes red when a problem has been detected on the projector.

AUTO PC button (P55)

Adjusts tracking and so on automatically in accordance with signal from a computer when ANALOG PC-1 or ANALOG PC-2 is selected.

POWER button/lamp (P47, P66)

Turns the projector on or off.
 Green: The projector is on.
 Flashing green: The projector is being turned on.
 Red: The projector can be turned on.
 Flashing red: The projector is being turned off (the lamp is being cooled).

LED illumination lamp (P100)

Indicates the projector status with LEDs.
 Blinking from the left: The projector is being turned on.
 Blinking from the right: The projector is being turned off.
 Middle LED flashing slowly: The image is being blanked out.
 Left and right LEDs flashing slowly: The image is freezing.

Input Terminals

■ SX80

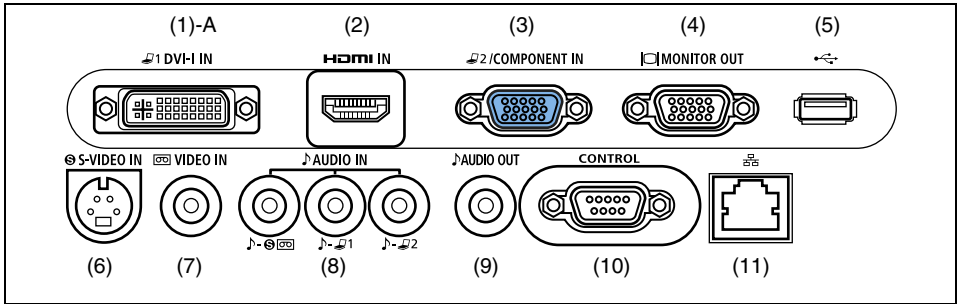

■ SX800

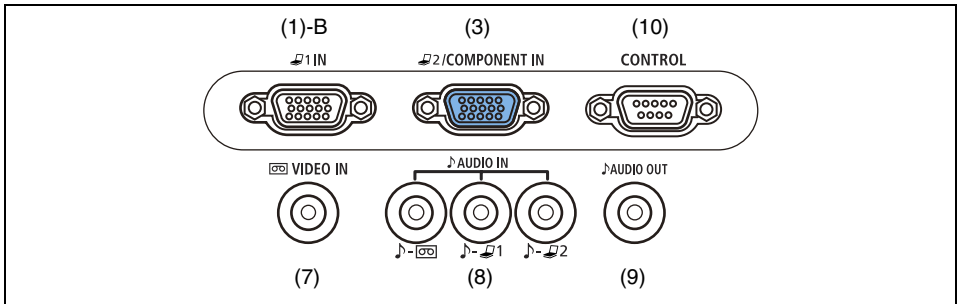

(1)-A ANALOG PC-1/DVI-I IN Input Terminal
(DVI-I IN) (SX80) (P38, P40)

(1)-B ANALOG PC-1 Input Terminal
(1 IN) (SX800) (P38)

Connects an external monitor output from a computer.

Receives an analog PC (ANALOG PC-1) or a digital signal (DIGITAL PC, SX80).

(2) HDMI IN Terminal (SX80) (P42)

Receives a digital content image signal (HDMI).

Carries both video and audio signals across a single cable.

(3) ANALOG PC-2/COMPONENT IN Terminal
(2/COMPONENT IN) (P39, P44)

Receives an analog PC signal (ANALOG PC-2).

Use a supplied component cable to receive a component image signal (COMPONENT).

(4) Monitor Output Terminal (MONITOR OUT) (SX80) (P40)

Outputs an analog RGB signal to display an image on an external monitor.

(5) USB Terminal (SX80) (P46)

Connects a digital camera or an USB flash memory.

(6) S-VIDEO IN Terminal (SX80) (P43)

Receives an S-Video signal from AV equipment.

(7) VIDEO IN Terminal (P43)

Receives a composite video signal from AV equipment.

(8) **♪ AUDIO IN Terminal (P38, P39, P40, P43, P44)**

The audio input terminals for 3 image input systems other than HDMI-IN.

They receive the following audio signals in order from the left.

SX80: "S-VIDEO or VIDEO", "DIGITAL PC/ANALOG PC-1", and "ANALOG PC-2/COMPONENT"

SX800: "VIDEO", "ANALOG PC-1", and "ANALOG PC-2/COMPONENT"

The internal speaker outputs the audio signal for the selected image signal.

(9) **♪ AUDIO OUT Terminal (P41, P45)**

The audio output terminal to output an audio to external AV equipment. It outputs the audio signal corresponding to the projected image signal.

(10) **Service port (CONTROL)**

Exclusively used by the service personnel (it is not used normally).

(11) **LAN port (SX80) (P120)**

Connects a LAN cable.

Used to connect the projector to the network.

Preparing the Remote Control

■ Installing Remote Control Batteries

- 1** Open the battery compartment lid. Slide the lid with it pressed down.

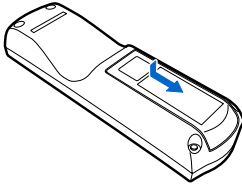

- 2** Insert batteries. Insert new two AAA-size batteries in the compartment with the + and – poles positioned correctly.

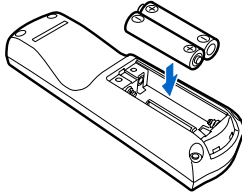

- 3** Replace the compartment lid.

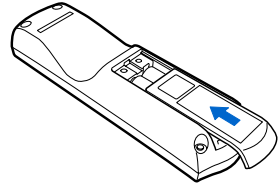

- If buttons on the remote control are inoperative when you attempt to operate the projector, replace the batteries with new ones.
- It is recommended to check the batteries before a presentation.

■ Remote Control Operating Range

Point the remote control to the infrared remote receiver on the front or rear of the projector whenever pressing any button.

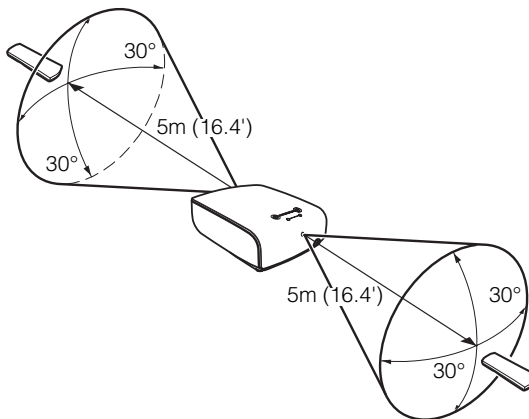

- Use the remote control within a distance of approximately 5 m (16.4') from the projector.
- Use the remote control within an angle of 30° in any direction from directly in front of the infrared remote receiver.
- The remote control may be inoperative if there is an obstacle between the remote control and main unit or the infrared remote receiver on the main unit is exposed to direct sunlight or strong light of lighting equipment.
- When you use two projectors at the same time, you can change the channel settings to prevent the two remote controls from interfering with each other. (P101)

Projecting an Image

Table of Contents

Safety Instructions

Before Use

Projecting an Image

Useful Functions Available During a Presentation

Setting Up Functions from Menus

Projecting an Image from a Digital Camera or an
USB Flash Memory (SX80)

Connecting the Projector to Network (SX80)

Appendix

Index

Steps for Setting Up the Projector and Projecting an Image

Connecting the Projector to Equipment (P36, P37)



Turning on the Power (P47)



Do you want to project an image from a notebook computer?

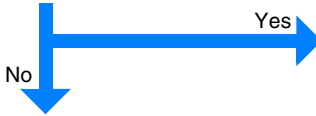

For a notebook computer, turn on the monitor output (P49) and then go to Auto Setup.

Performing the Auto Setup (P50)

Image projected properly?

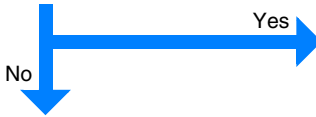

In SX800, manually adjust the focus.

Projection is complete.

Selecting an Input Signal (P52)

Image projected properly?

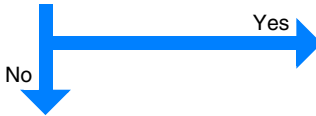

Projection is complete.

Adjusting the Image (P54)

Do the following adjustments.

- Setting the Display Resolution of the Computer (P54)
- Adjusting misaligned computer images or flickering of the screen using the Auto PC (P55)
- Adjusting the Image Size (P56)
- Adjusting the Focus (P57)
- Adjusting keystone Distortion (P58)

Making Fine Adjustments

- Selecting an Aspect Ratio of Projected Image (Screen aspect) and a Screen Mode (Aspect) (P60, P63)
- Selecting an Image Mode (P65)

Setting Up the Projector

■ Placing in Front of the Screen

Place the projector in front of the screen.



- Be sure to place the projector parallel to the screen to ensure distortion-free projections.
- The screen must not be exposed to direct sunlight or light from lighting equipment. In a bright room, it is recommended to limit ambient lighting in order to improve the image quality.

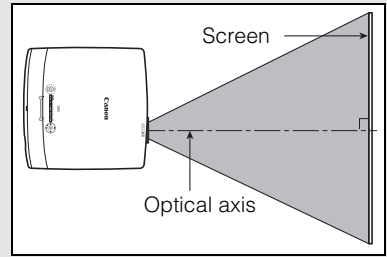

Projected Image Size

The projected image size is determined by the distance between the projector and the screen (projection distance) as well as the zoom (P56). For the relationship between the screen size and the projection distance, see also the table listed in "Relationship between Screen Size and Projecting Distance" on page 139.

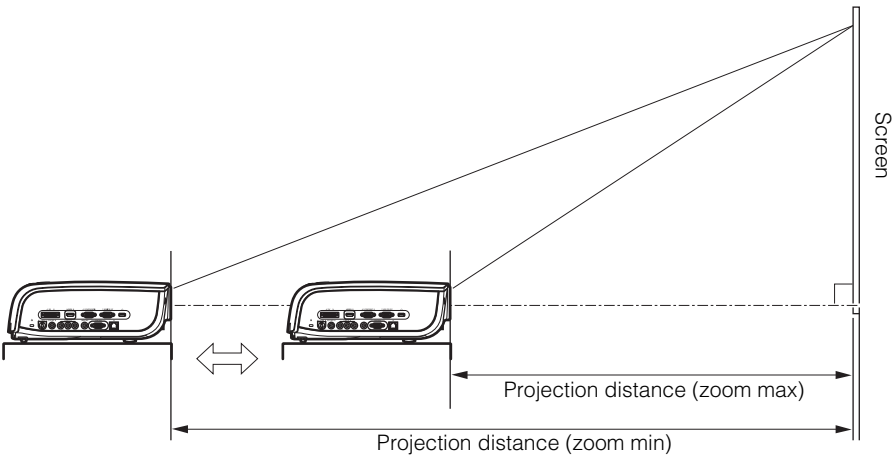

Screen size	40	60	80	100	150	180	200	250	300
Width (cm)	81	122	163	203	305	366	406	508	610
Height (cm)	61	91	122	152	229	274	305	381	457
Projection distance (zoom max)	1.2 m (3.9')	1.8 m (5.9')	2.4 m (7.9')	3.0 m (9.8')	4.5 m (14.8')	5.4 m (17.7')	6.0 m (19.7')	7.6 m (24.9')	9.1 m (29.9')
Projection distance (zoom min)	1.7 m (5.6')	2.6 m (8.5')	3.5 m (11.5')	4.4 m (14.4')	6.6 m (21.7')	8.0 m (26.3')	8.9 m (29.2')	-	-

■ Placing on a Level Place

Be sure to keep the projector as horizontal as possible.

If you need to point the projector up (for example, when the screen is placed on a higher position), follow the instruction given in "When Pointing the Projector Up" on the following page.

- Adjust the tilt of the projecting image using the rear adjustable foot.

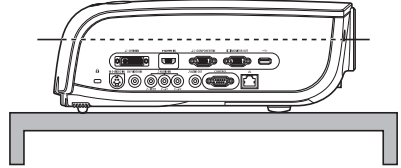
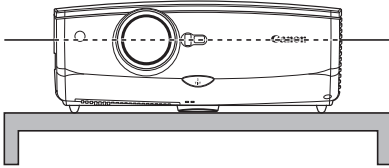

Make sure that the installation position is free from any obstacle that may block the exhaust vent on the right side of the projector and the air intake vent on the bottom of the projector.

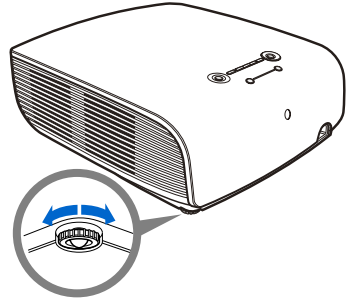

Ceiling Mounting or Rear Projection

You can mount the projector on the ceiling (Ceiling mounted) with it turned up side down or place it behind the screen (Rear) if you use a translucent screen. For ceiling mounting or rear projection, you have to invert the projected image. (P85)

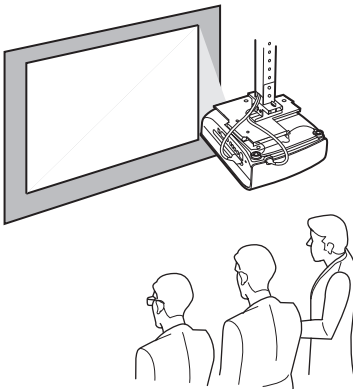

Ceiling Mounting

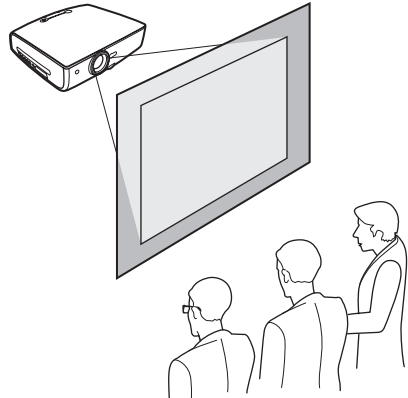

Rear Projection

■ When Pointing the Projector Up

When the screen is placed on a higher position, point the projector up using the adjustable foot.

You can point it up as far as 10 degrees.

The keystone distortion of the projecting image can be corrected with the auto keystone (P50) or by using the keystone distortion adjust function (P58).

- 1** Lift the front side of the projector and push the adjusting foot lock button to extend the adjustable foot.
- 2** Raise the image to the desired height angle, then release the button to lock the foot in place.

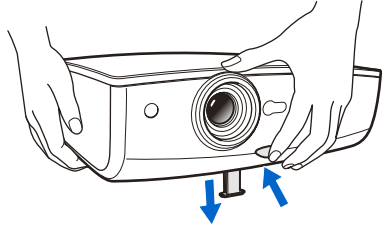

If Keystone Distortion is Too Large

If the keystone distortion is too large to adjust, adjust the projector height by, for example, placing it on a pedestal.

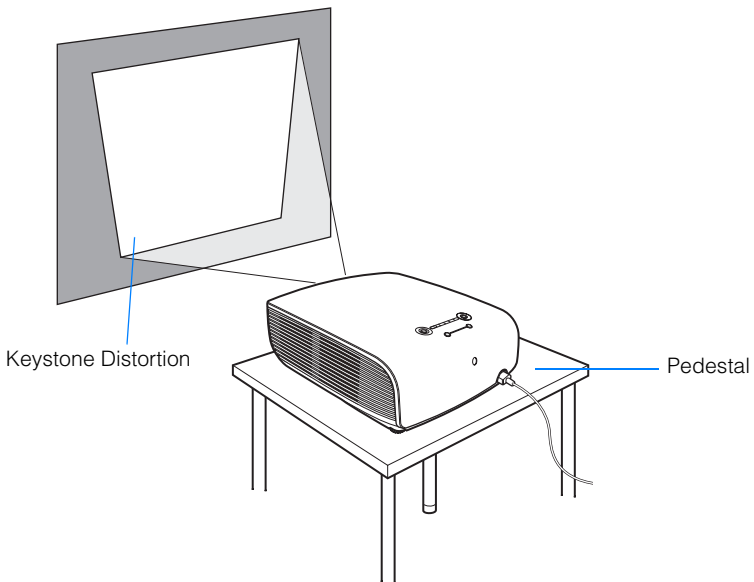

Connecting the Projector

Connectable Equipment and Input Terminals

DIGITAL PC ANALOG PC-1	Use this name to select the appropriate image.	↓ : Video signal or data flow
DVI-I IN terminal	The name of the terminal to which to connect equipment.	(Pxxx) : indicates the page(s) to refer to.

■ SX80

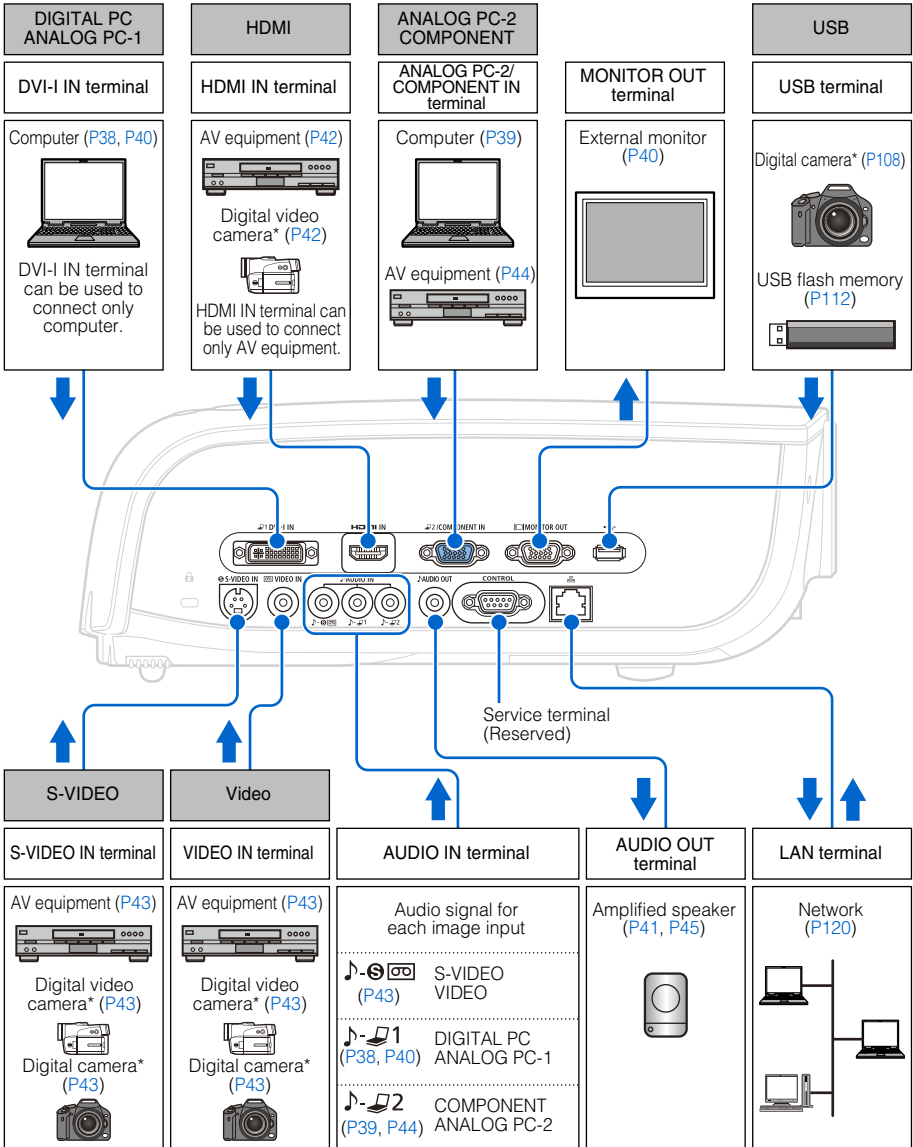

* Connect to the playback mode.

■ SX800

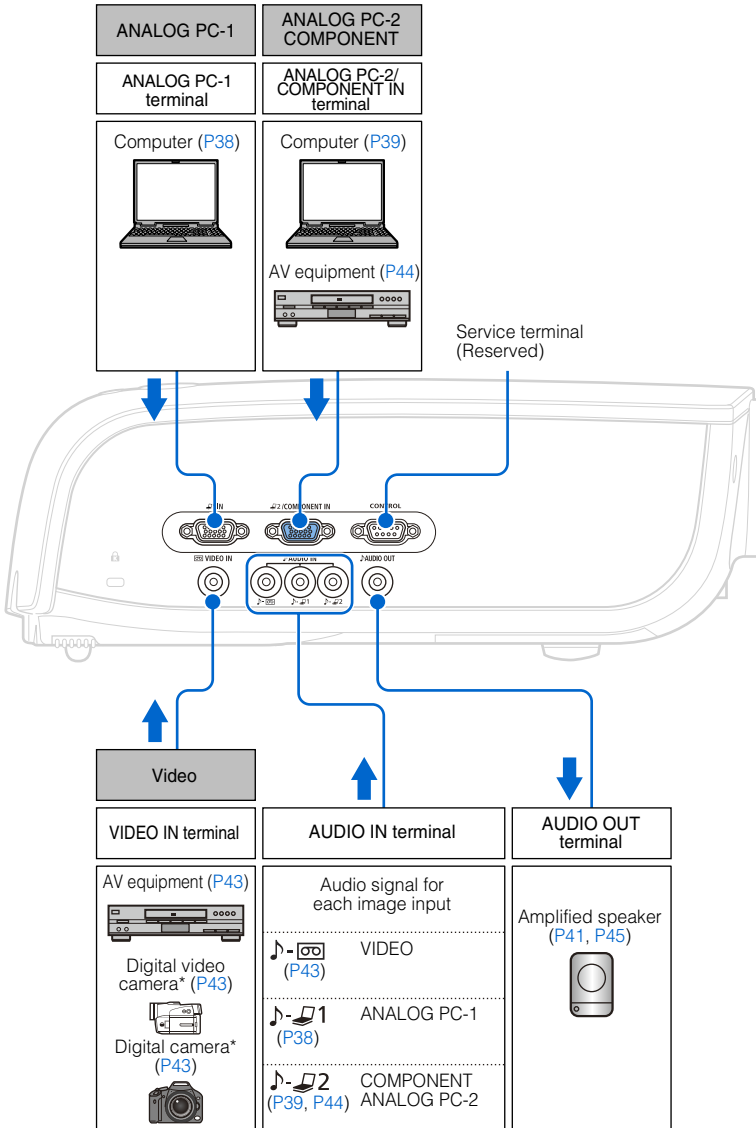

* Connect to the playback mode.

Connecting the Projector to the Computer

Connect the projector to the computer.

Before connecting the cables, turn off both the projector and computer.

■ Connecting to RGB Monitor Output Terminal (analog connection)

Supplied computer connection cable (Input signal type: [ANALOG PC-1] - P52)

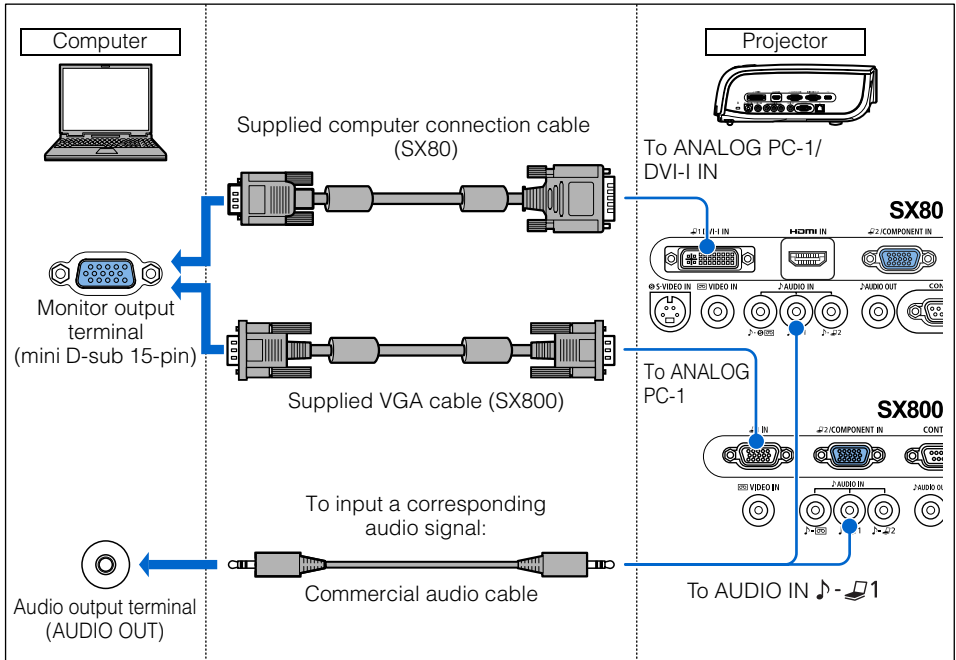

Use an audio cable without a built-in resistor. Using an audio cable with a built-in resistor turns down the sound.

Commercial or supplied VGA cable (Input signal type: [ANALOG PC-2] - P52)

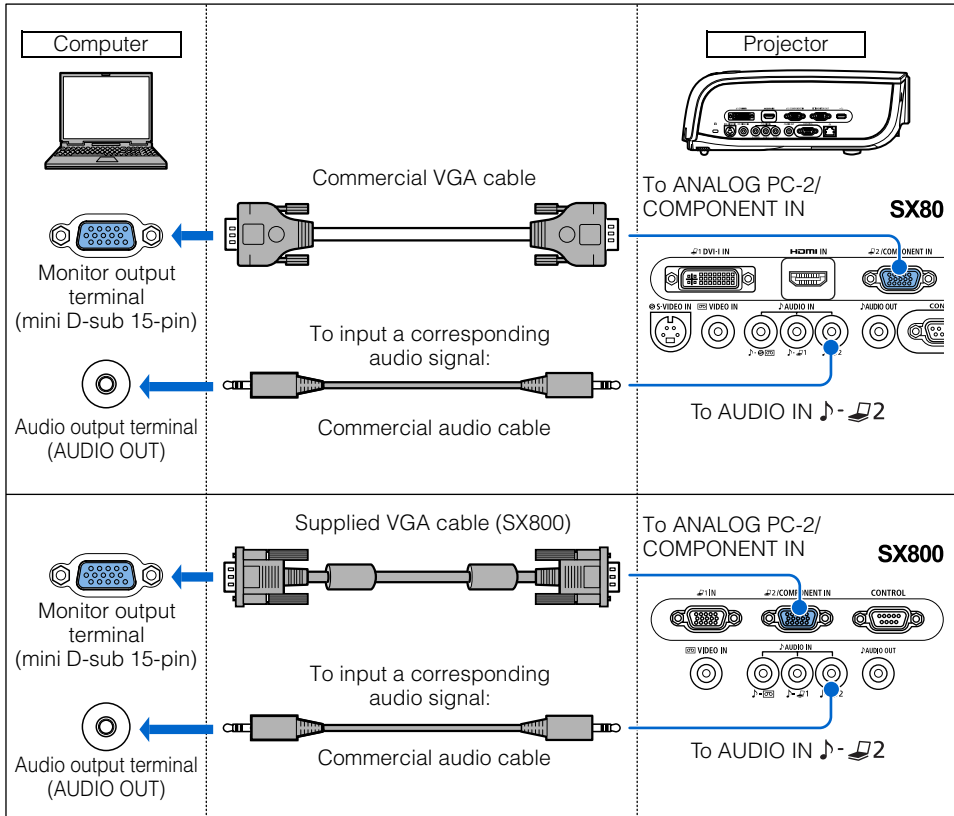

Projecting an Image

- If you use a commercial VGA cable, make sure to use a full connected VGA cable in which all pins are connected; otherwise, an image may be projected improperly.
- Use an audio cable without a built-in resistor. Using an audio cable with a built-in resistor turns down the sound.

■ Connecting to DVI Monitor Output Terminal (digital connection) (SX80)

DVI cable (Input signal type: [DIGITAL PC] - P52)

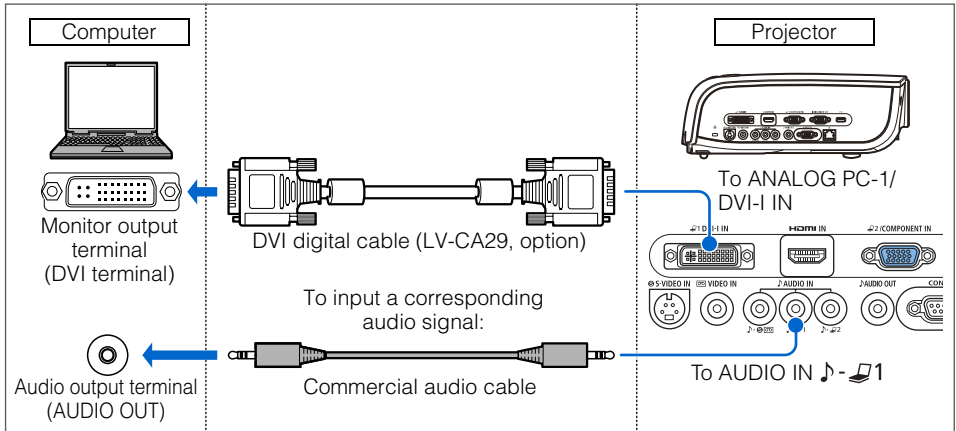

Use an audio cable without a built-in resistor. Using an audio cable with a built-in resistor turns down the sound.

■ Outputting an Image and Audio

Outputting an Image (SX80)

Images can be output to an external monitor via [ANALOG PC-1], [ANALOG PC-2] and [COMPONENT].

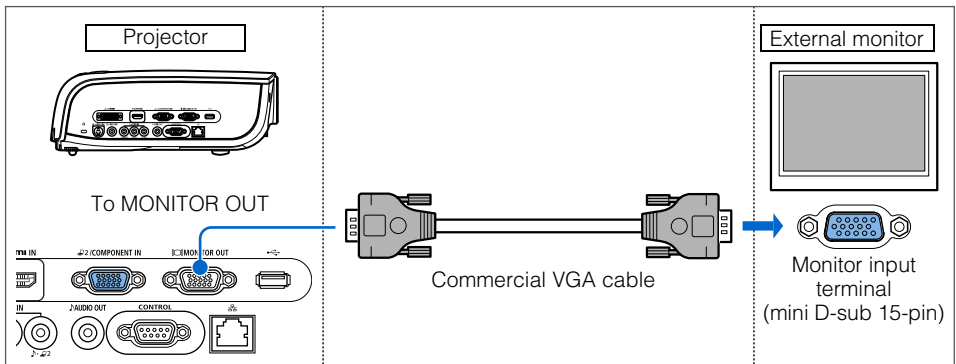

- You can connect one external monitor.
- It outputs an image of the analog PC or component video signal, whichever was previously selected

Outputting Audio to Speakers

It is possible to output sound of projected images to AV equipment or amplified speakers.

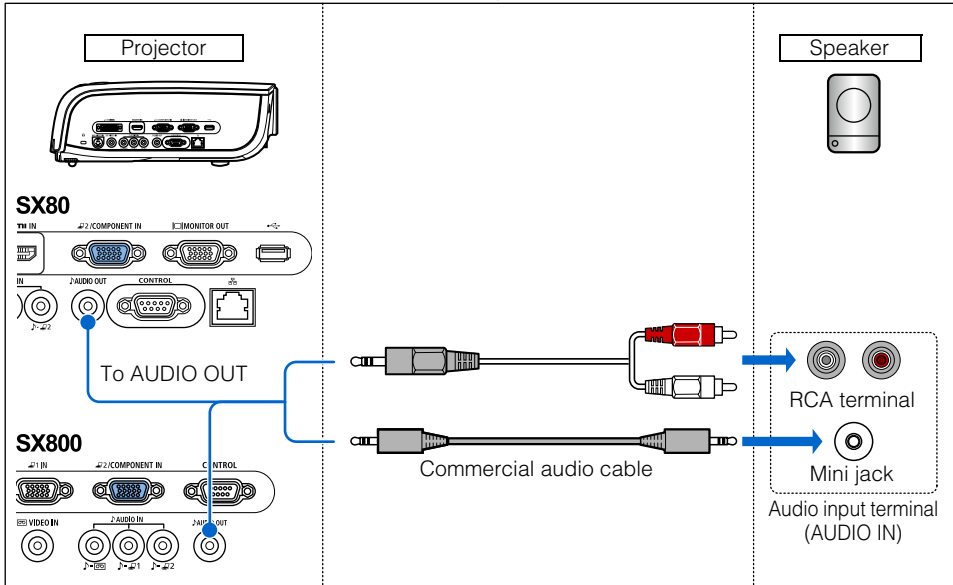

- The speaker outputs the audio signal corresponding to the selected image signal.
- Use an audio cable without a built-in resistor. Using an audio cable with a built-in resistor turns down the sound.

Connecting to AV Equipment

Connect the projector and AV equipment.

Before connecting the cables, turn off both the projector and AV equipment.

The description provided here is just examples. For more detailed information, refer to the manual for the connecting AV equipment.

■ Connecting to Digital Video Output Terminal (digital connection) (SX80)

HDMI cable (Input signal type: [HDMI] - P52)

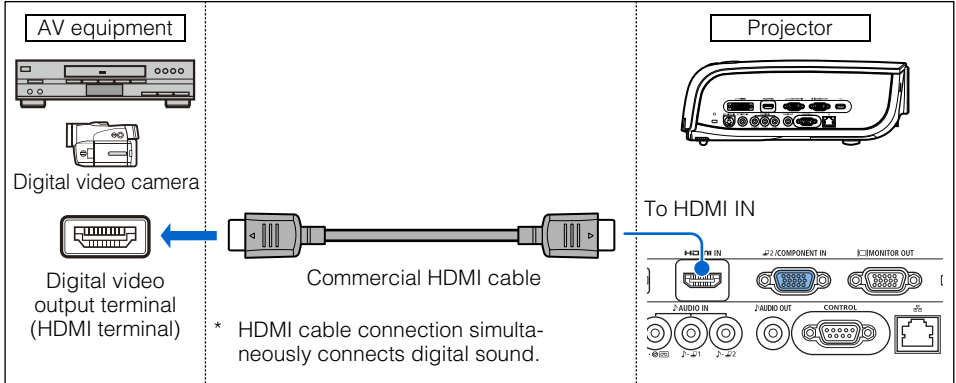

■ Connecting to Analog Video Output Terminal (analog connection)

Video cable (Input signal type: [VIDEO] or [S-VIDEO] - P52)

Connect the projector and AV equipment using a video or S-VIDEO cable that fits to the terminal type of the AV equipment.

The input signal type is [VIDEO] or [S-VIDEO].

Sound is common to [VIDEO] and [S-VIDEO].

[S-VIDEO] is supported only in SX80.

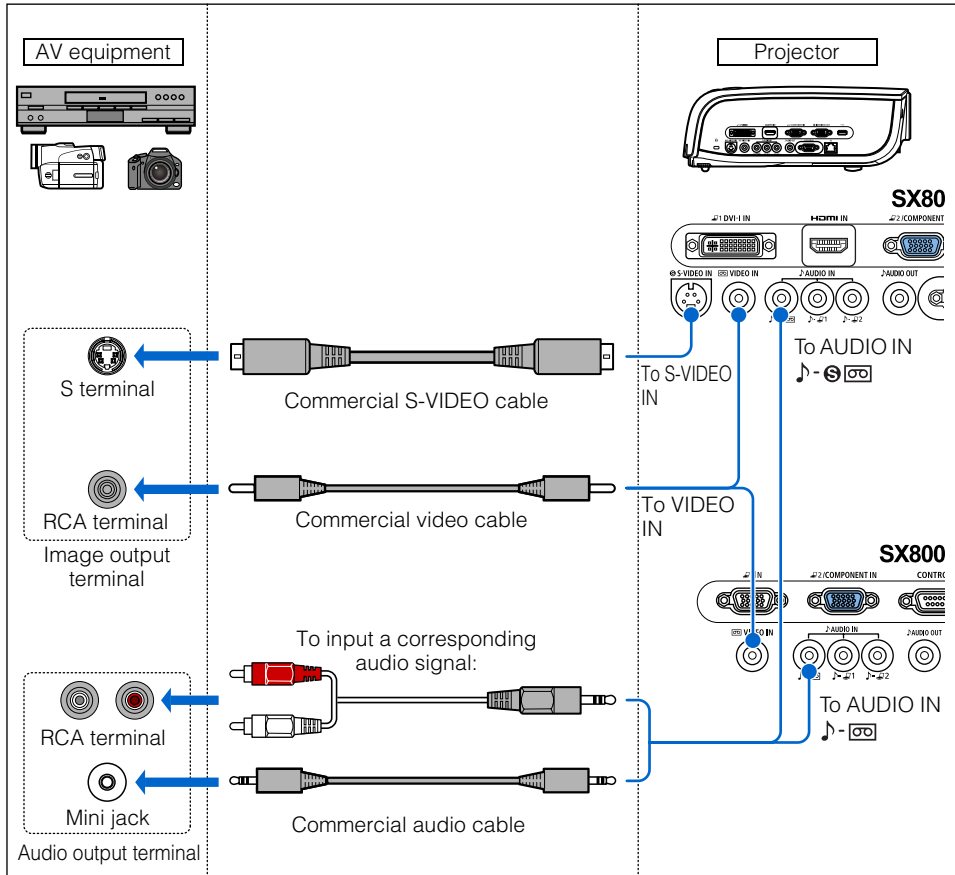

Projecting an Image



Use an audio cable without a built-in resistor. Using an audio cable with a built-in resistor turns down the sound.

Connecting the Projector

Supplied component cable (Input signal type: [COMPONENT] - P52)

A Component video signal from AV equipment can be input to the projector by connecting the supplied component cable to the ANALOG PC-2/COMPONENT IN terminal of the projector.

Use a commercial component cable that fits to the terminal type of the AV equipment to connect the supplied component cable.

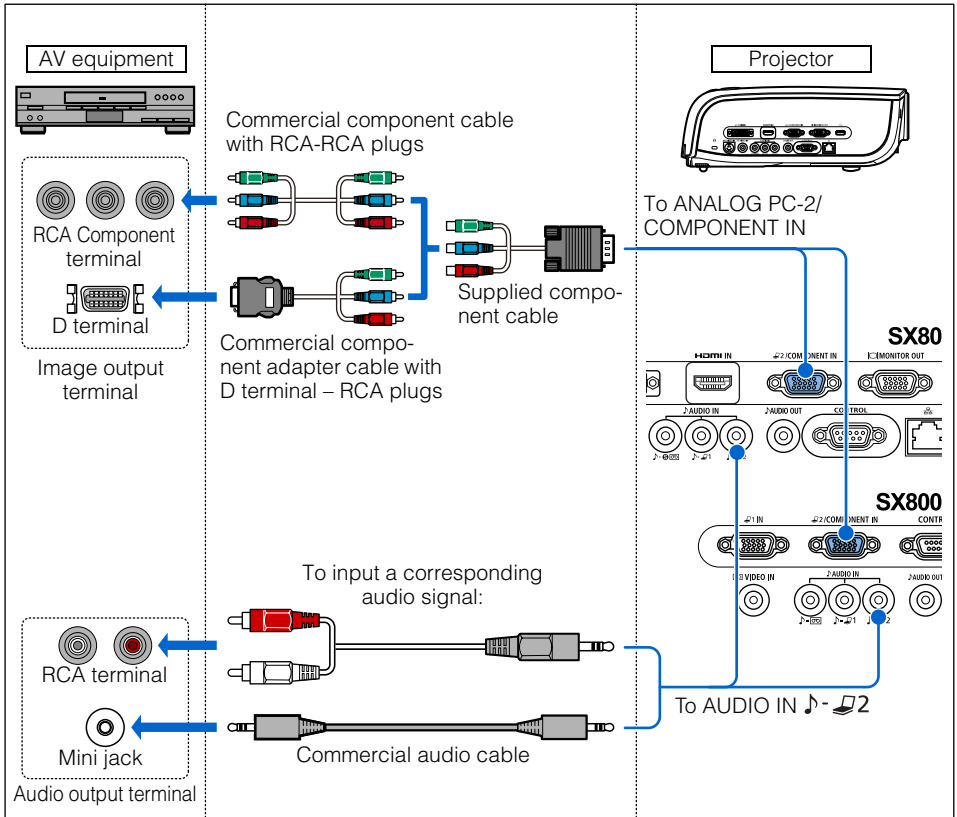

Use an audio cable without a built-in resistor. Using an audio cable with a built-in resistor turns down the sound.

■ Outputting Audio to Speakers

It is possible to output sound of projected images to AV equipment or amplified speakers.

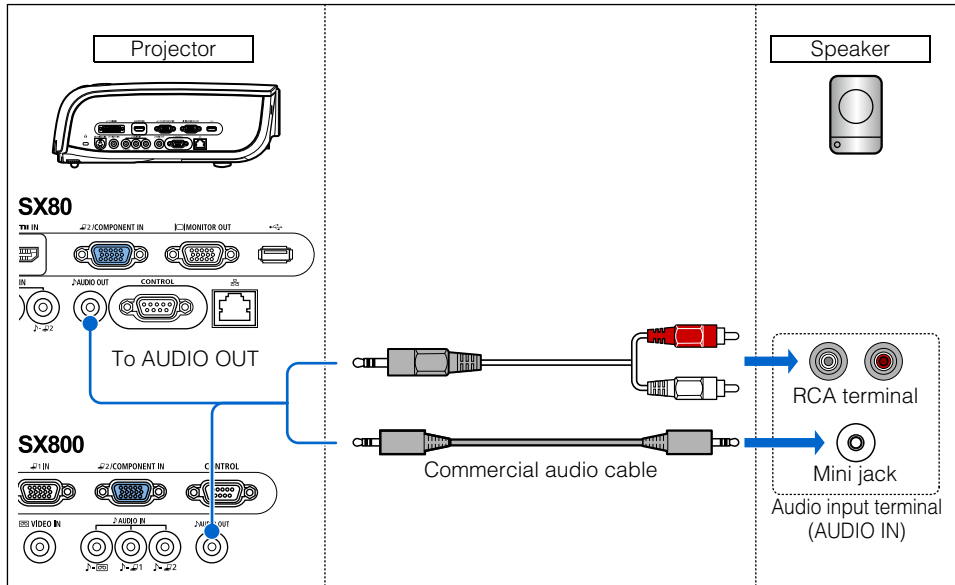

Use an audio cable without a built-in resistor. Using an audio cable with a built-in resistor turns down the sound.

■ Connecting a Digital Camera or an USB Flash Memory (SX80)

SX80 supports PictBridge.

You can connect a PictBridge enabled digital camera, a digital video camera, an USB flash memory, or an USB memory card reader to directly project images.

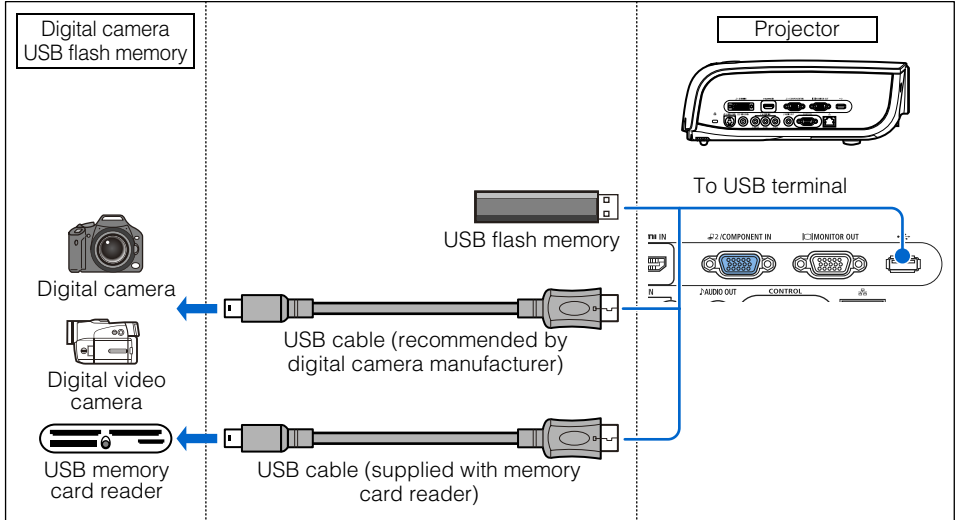

Starting Projection

- 1** Check the connection between the projector and a computer or AV equipment. (P36 – P46)
- 2** Connect the power cord and make sure that the [POWER] indicator lights up red. Flashing red [POWER] indicator indicates that the lamp is being cooled. Wait until the indicator turns a steady red.

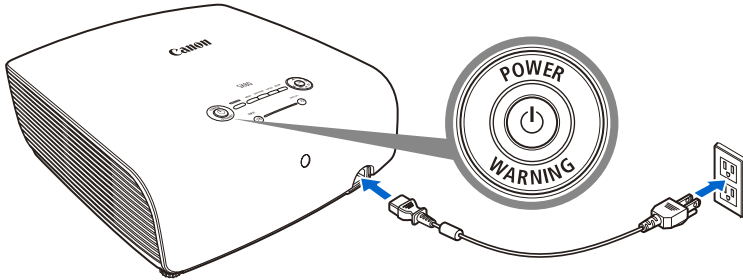

- Fully insert the power cord plug into the socket.
 - Connect the ground terminal on the power plug to ground. Otherwise, an electric shock may result or the computer may suffer electromagnetic radiation problems or be subject to poor reception by TV and radio.
 - Wait at least 5 minutes before turning on the projector when you turn off the projector. It may shorten the lamp life if you turn on the projector immediately after turning it off.
 - To save power, unplug the power cord when not in use.
- 3** Remove the lens cap and press the **POWER** button. The **POWER** indicator flashes green, and then lights in green.

Remote control

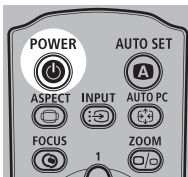

Top control

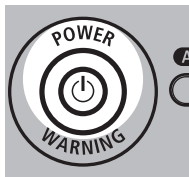

The countdown window is displayed for approximately 20 seconds, and then the projection is started. Press the **OK** button to make the countdown window disappear.

- 4** Turn on the computer or AV equipment power.

Changing Operations When Projector is Turned On

You can change operations when the projector is turned on as follows:

- You can turn on the projector by connecting the power cord without pressing the **POWER** button. (P98)
- You can specify whether to enable or disable the LED illumination lamp. (P100)
- You can change the countdown window. (P88)
- You can skip the countdown window. (P47)

Using the Power Saving Mode (power management)

When you enable the power management mode, the lamp is automatically turned off if the projector receives no signal input for a certain period of time. (P97)

5 Press the AUTO SET button.

The auto setup function performs the following operations automatically:

SX80: focusing and keystone distortion adjustment, input signal setting, and screen color correction

SX800: keystone distortion adjustment and input signal setting

For more details, refer to the page 50.

If the projector is projecting an image properly with [AUTO SETUP], the projection is complete.

In SX800, adjust the focus and correct the screen color manually.

For how to turn off the projector, refer to the page 66. Perform the appropriate operation depending on the following situations.

■ When the Language Selection Screen Appears

A window appears when the projector is turned on for the first time. You can select a language to be used by the projector for displaying menus and messages in the window.

Select the desired language with the pointer buttons and press the **OK** button.

You can change the language from the menu at a later time. (P99)

If you cannot check the language selection screen due to the out of focus, press the **FOCUS** button to adjust the focus. (P57)

Remote control

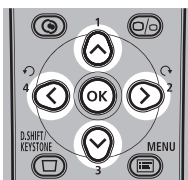

Top control

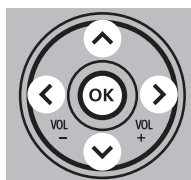

Language		
English	Русский	Čeština
Deutsch	Nederlands	Dansk
Français	Suomi	إنجليزي
Italiano	Norsk	中文简体
Español	Türkçe	中文繁體
Português	Polski	한국어
Svenska	Magyar	日本語

An item highlighted in orange will be selected.

■ When the Password Input Screen Appears

If you have set a password, the Password input screen appears. Enter your password. (P102)

■ When "No signal" Appears

A notebook computer requires to turn on the external monitor output. (P49)
Press the **INPUT** button to select an appropriate input signal. (P53)

■ When Notebook Computer Screen Does Not Appear

Set your notebook computer to output signals to an external monitor. For more details, refer to "Changing Notebook Computer Screen Output" below.

■ Adjusting Image

- For the display resolution of the computer, select "1400 x 1050 pixels" or a resolution closest to the output signal resolution of the computer. (P54)
- Use the auto PC function to adjust shift in computer image or the flickering of the screen. (P55)
- Use the **ZOOM** button to adjust the size of the projecting image. (P56)
- Use the **FOCUS** button to correct the focus adjustment if necessary. (P57)
- Use the **D.SHIFT/KEYSTONE** button to adjust keystone correction if necessary. (P58)
- Select the aspect ratio of the projecting image (screen aspect) or a screen mode (aspect) according to the aspect ratio of the screen, type of input image signal and so on. (P60 - P64)
- Select an image mode depending on the projecting image. (P65)

Changing Notebook Computer Screen Output

To use a notebook computer, you need to change the screen output on the notebook computer.

This operation is not required for a desktop computer.

■ Turning On External Monitor Output

You can turn on the external monitor output via keyboard operation.

To turn on the external monitor output, press an icon for an external monitor or a function key ([F1] to [F12]) while holding [Fn] key down.

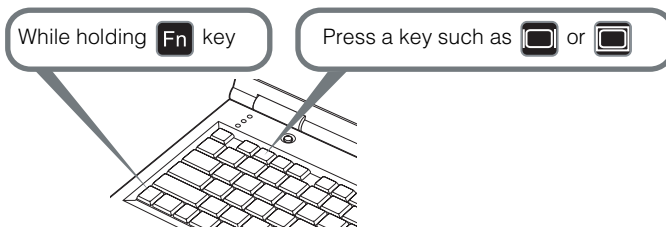

The function keys you use and the method used to turn on the external monitor output vary depending on the model. For details, see the instructions of your notebook computer.

Setting Up the Screen Automatically

Auto Setup

The auto setup function automatically makes the following settings and adjustments.

Setting image input signal (Auto input)

Focusing (Auto focus) (SX80)

Keystone correction (Auto keystone)

Screen color correction (Auto screen color correction)
(SX80)

Use the auto setup function when:

- You turned the power on and the countdown sequence was completed.
- You changed the position or angle of the projector during the projection process.



- The auto screen color correction is disabled at the factory. To enable the auto screen color correction when performing the auto setup, select the function in menu. (SX80) (P84)
- You cannot set a digital PC signal or an AV equipment signal ([Digital PC] and [HDMI]) with the auto setup function. Select the appropriate signal by pressing the **INPUT** button. (SX80) (P53)
- When "No signal" message appears, press the **INPUT** button to select an appropriate input signal. (P53)
- If focusing, keystone distortion and/or screen color correction have not been performed properly, manually adjust them. (Adjusting the focus: P57, Correcting keystone distortion: P58 and Correcting the screen color: P84)
- In SX800, the auto setup function does not adjust the focus. Please manually adjust the focus. (P57)
- If you select [16:9 D. image shift] for [Screen aspect], [Auto setup] will be disabled and the following screen appears.

SX80

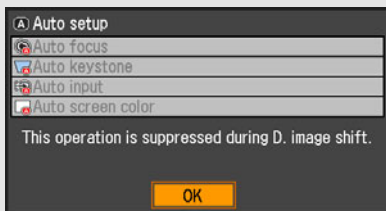

SX800

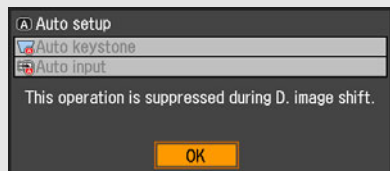

- When you press the **INPUT** button and then the **AUTO SET** button, only the input signal type is set.
- When you press the **FOCUS** button and then the **AUTO SET** button, only the focus is adjusted. (SX80)
If you select [16:9 D. image shift] for [Screen aspect], the auto focus function will be disabled.
- When you press the **D.SHIFT/KEYSTONE** button and then the **AUTO SET** button, only the keystone distortion is adjusted. If you select [16:9 D. image shift] for [Screen aspect], the keystone adjustment will be disabled.

■ Performing the Auto Setup

Press the **AUTO SET** button to perform the auto setup.

Remote control

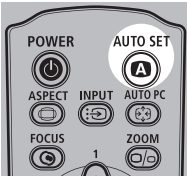

Top control

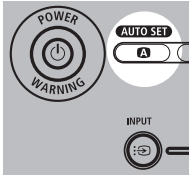

- After the auto setup is complete, the following window appears. Press the **OK** button.

SX80

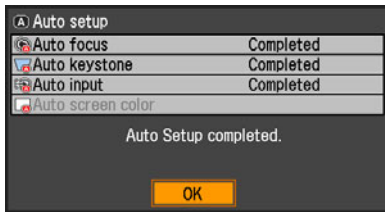

SX800

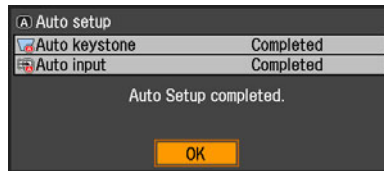











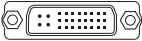
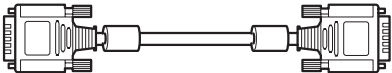

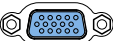
Selecting an Input Signal (INPUT)

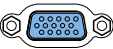
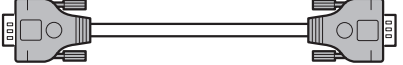
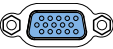
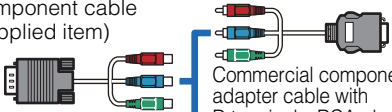
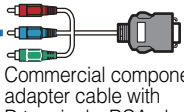
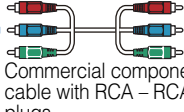
Select an appropriate input signal in the [INPUT] menu if you want to project a digital PC or AV equipment signal or you connect multiple computers or AV equipment to receive their input signals. Skip this step if you have not changed the input signal since the last projection.

■Types of Input Signals

The table below shows the relationship among input signals supported by the projector, input terminals and connection cables.

Input signal	Supported model	Input terminal	Types of connection cables
HDMI	SX80	HDMI IN 	HDMI cable (commercial item) 
DIGITAL PC	SX80	ANALOG PC-1/ DVI-I IN 	DVI digital cable (LV-CA29, option) 
ANALOG PC-1	SX80	ANALOG PC-1/ DVI-I IN 	Computer connection cable (supplied item) 
	SX800	ANALOG PC-1 	VGA cable (supplied item) 
ANALOG PC-2	SX80 SX800	ANALOG PC-2/ COMPONENT IN 	VGA cable (commercial item) 
COMPONENT	SX80 SX800	ANALOG PC-2/ COMPONENT IN 	Component cable (supplied item)  Commercial component adapter cable with D terminal – RCA plugs  Commercial component cable with RCA – RCA plugs 
VIDEO	SX80 SX800	VIDEO IN 	Video cable (commercial item) 
S-VIDEO	SX80	S-VIDEO IN 	S-VIDEO cable (commercial item) 
USB	SX80	USB 	USB cable or USB flash memory (commercial item)

■ Selecting an Input Signal

1 Press the INPUT button to pop up a window shown at the lower right.

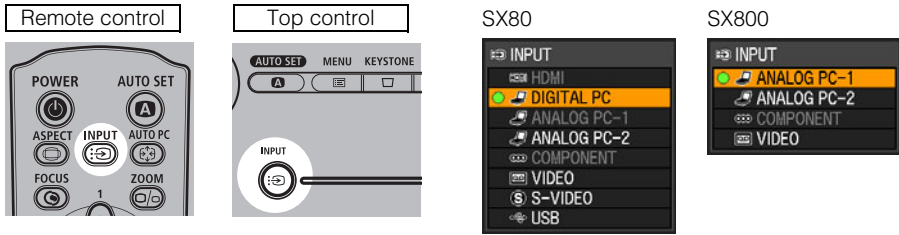

The currently active input signal is marked with a circle and highlighted in orange. An input signal that is ready for projection is displayed in white. When no signal is received, it is displayed in gray. In SX80, [HDMI], [DIGITAL PC], and [ANALOG PC-1] may be displayed in gray even if they are ready for projection.



When you select [USB] with no PictBridge enabled equipment or a USB flash memory connected and pressing the OK button, a window waiting for you to connect a PictBridge enabled equipment or a USB flash memory appears. For more details, refer to "Projecting an Image from a Digital Camera (SX80)" (P108 – P111) or "Projecting Data on USB Flash Memory (SX80)" (P112 – P118).

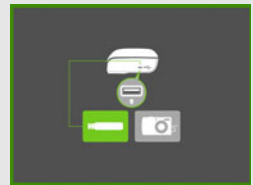

2 The selection is toggled through available input signal types by pressing the INPUT button.

- You can select the target input signal with [\wedge] / [\vee].
- Only the input signals displayed in white can be selected.

3 Press the OK button to determine the input signal type.

If no button is pressed in 4 seconds, the selected input signal type is chosen.

Adjusting Image

Setting the Display Resolution of the Computer

Set the display resolution of the computer to "1400 x 1050 pixels" or a resolution closest to the output signal resolution of the computer based on the performance of the projector (resolution: 1400 x 1050 pixels). (P138)

■ Windows Vista

- 1 Open the [Control Panel] from the start menu, then select [Appearance and Personalization] - [Adjust screen resolution] in the [Control Panel Home].
- 2 Select "1400 x 1050 pixels" or a resolution closest to the output signal resolution of the computer.
- 3 Click the OK button.

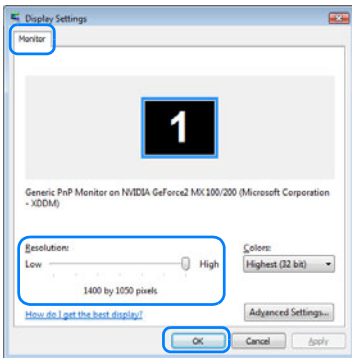

■ Windows XP

- 1 Right-click on the desktop background and select [Properties] to open the [Display Properties].
- 2 Click the [Settings] tab, and under [Screen Resolution], select "1400 x 1050 pixels" or a resolution closest to the output signal resolution of the computer.
- 3 Click the OK button.

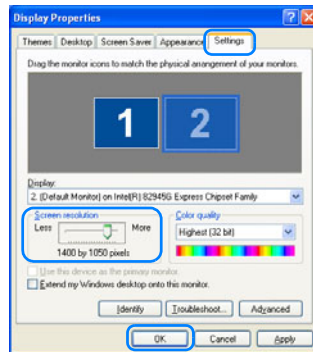

■ Macintosh OSX

- 1 Open the Apple Menu and select [System Environment Setting].
- 2 In the System Environment Setting window, click the [Displays] icon to display the Display window.
- 3 Select the [Display] tab and select "1400 x 1050" or a resolution closest to the output signal resolution of the computer from the [Resolution] list.
- 4 Close [System Environment Setting] window.

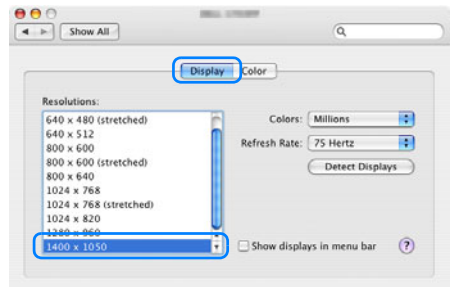

AUTO PC

When you press the **AUTO PC** button if there is a shift in image display or flickering of screen with the [ANALOG PC-1] or [ANALOG PC-2] selected, the projector is adjusted to an optimum condition.

The result of adjustment is recorded for each input signal ([ANALOG PC-1] or [ANALOG PC-2]). If you connect the projector to the same computer, you can project the image with the same settings as before simply by select the input signal.

■ Performing the Auto PC Function

Press the **AUTO PC** button to make projector adjustment.

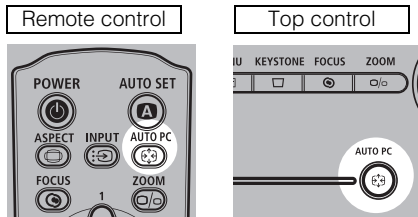

Perform the following if the project image has not been properly adjusted with the auto PC function.

- From [Input signal select], select an input signal type based on the resolution of the computer. (P78)
- If the adjustment is still insufficient, from [Input signal settings] select [Total dots], [Tracking], [Horizontal position], [Vertical position], [Horizontal pixels] and [Vertical pixels] to make adjustments. (P79 – P82)
- For the signal types supported by the projector, see the table on page 138.

Adjusting the Image Size

Use the **ZOOM** button to adjust the size of the projecting image.
 Change the projector installation position if your desired image is too large or too small to adjust it with the zoom function. (P33)

- 1 Press the **ZOOM** button to pop up a window shown at the lower right.

Remote control

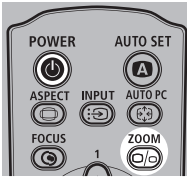

Top control

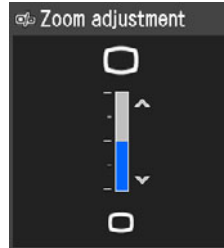
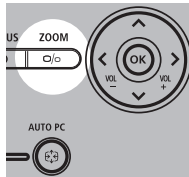

- 2 Press the pointer buttons to adjust the image size.

Remote control



Top control

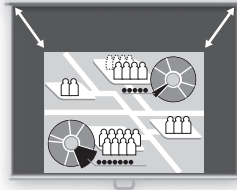
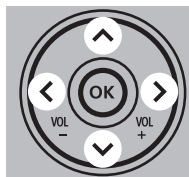

[^] / [v]: Rough adjustment.
 [<] / [>]: Fine adjustment.

- 3 When the image size is determined, press the **OK** button or the **ZOOM** button.

Adjusting the Focus

You can adjust the focus with the **FOCUS** button. The projection image may be out of focus if the projection distance is beyond the range of 1.2 m (3.9') to 9.1 m (29.6'). Move the projector installation position if such is the case. (P33)

■ Auto focusing (SX80)

Press the **FOCUS** button, and then the **AUTO SET** button.



If you select [16:9 D. image shift] for [Screen aspect], the auto focus function will be disabled.

■ Manual focusing

- 1 Press the **FOCUS** button to pop up a window shown at the lower right.

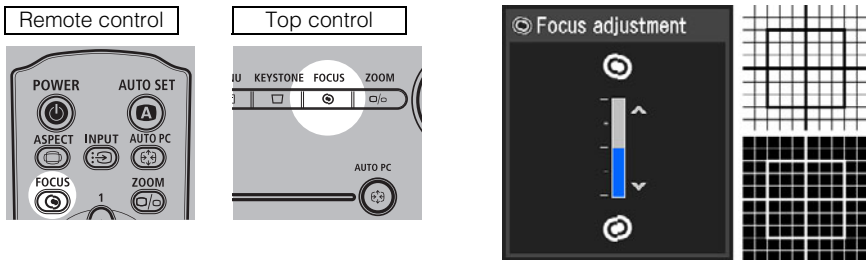

- 2 Press the pointer buttons to adjust the focus.

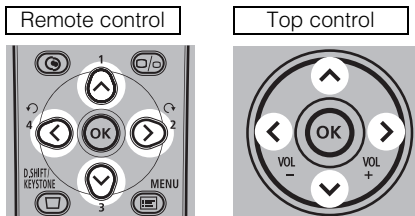

[\wedge] / [\vee]: Rough adjustment.

[<] / [>]: Fine adjustment.

- 3 When the focus is adjusted optimally, press the **OK** button or the **FOCUS** button.

Adjusting Keystone Distortion

The D.SHIFT/KEYSTONE button corrects the keystone distortion.



- Keystone can be adjusted within the range of ± 20 degrees. If the keystone distortion is too large to adjust, move the projector installation position. (P33)
- The amount of adjustment may be smaller depending on type of input signal.
- The result of keystone adjustment is memorized. If you place the projector at the same position, the keystone adjustment is not necessary.
- Signals are processed digitally when keystone distortion is corrected. The image may look different from the original one. In addition, the aspect ratio of the image may change.
- If you select [16:9 D. image shift] for [Screen aspect], the keystone adjustment will be disabled. Project the image at right angle to the screen.

■ Auto adjustment

Press the D.SHIFT/KEYSTONE button, and then the AUTO SET button.

■ Manual adjustment

1 Press the D.SHIFT/KEYSTONE button to pop up a window shown at the lower right.

Remote control

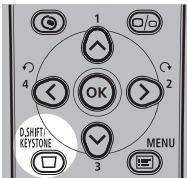

Top control

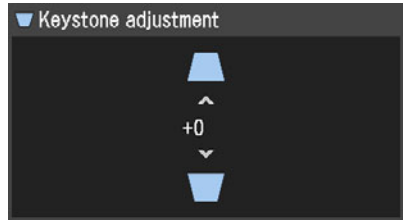
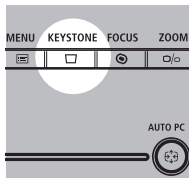

2 Press the pointer buttons to adjust the focus.

Remote control



Top control

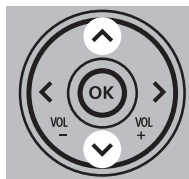

[^]: Reduces the length of the upper edge.

[v]: Reduces the length of the lower edge.

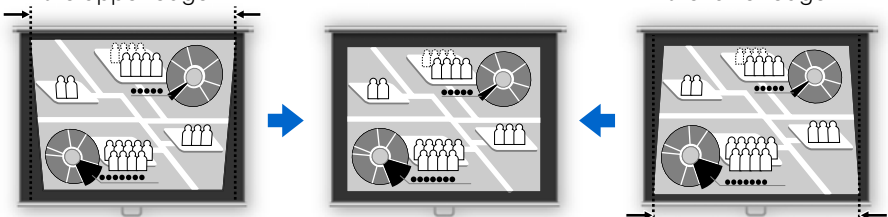

3 When the keystone distortion has been adjusted, press the OK button.

■ Resetting the Keystone Adjustment

Perform the following steps to reset the keystone adjustment.

Press the **D.SHIFT/KEystone** button twice to display the [Keystone reset] window.

On the window, select [OK] with [**<**], and then press the **OK** button.

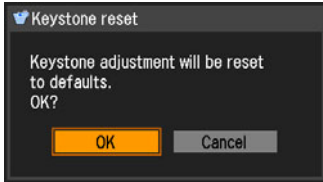

Selecting Screen Aspect and Aspect

Select an optimum aspect ratio of the projecting image (screen aspect) or an optimum screen mode (aspect) according to the aspect ratio of the screen, type of input image signal and so on for the projection making best use of the screen size.

- [Screen aspect]: Select the same aspect ratio with your screen.
- [Aspect]: Select [Auto] unless the type of input signal is [VIDEO].

You may need to change the setting depending on the resolution of the computer. If the image is not projected with a desired aspect ratio, see "Relationship between Aspect and Screen Aspect" in Appendix on page 135.

Selecting Screen Aspect

Select the aspect ratio of projecting image to the aspect ratio of the screen.
Perform the following steps to select the aspect ratio of the projecting image.

1 Press the MENU button to display a menu window.

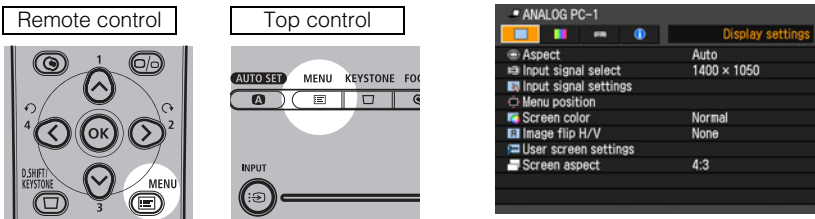

2 Use [←] / [→] to select the [Display settings] tab.

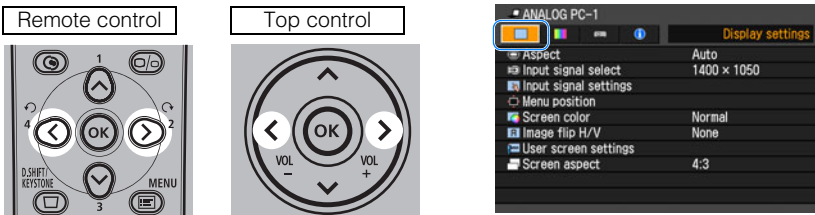

3 Select [Screen aspect] with [↑] / [↓], and then press the OK button.



4 Use [\wedge] / [\vee] to select a screen aspect type.

Remote control

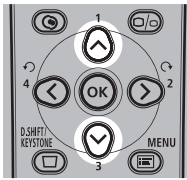

Top control

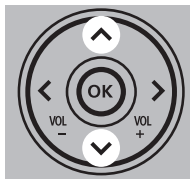

4:3

Select this when you use a screen with aspect ratio of 4:3.

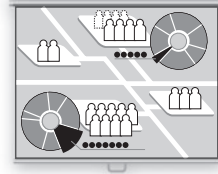

16:9

Select this when you use a screen with aspect ratio of 16:9.

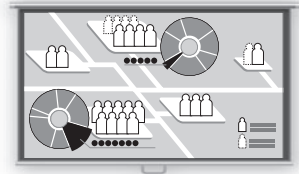

16:9 D. image shift

Select this when you use a screen with aspect ratio of 16:9. Suitable for projecting visual software having aspect ratio of 16:9.

You cannot correct the keystone distortion in this mode, but you can move the image up or down with images being projected horizontally.

See the following page on how to shift the image.



5 Press the OK button to accept your setting and then press the MENU button.

■ Moving Image with 16:9 D. Image Shift

1 Press the D.SHIFT/KEystone button to pop up a window shown at the lower right.

Remote control

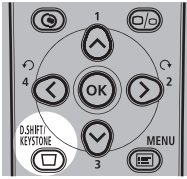

Top control

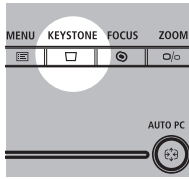

2 Use [\wedge] / [\vee] to move the image.

Remote control

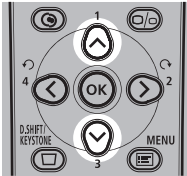

Top control

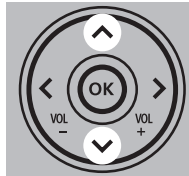

[\wedge]: Moves up the image.

[\vee]: Moves down the image.



3 When the image shift adjustment has been completed, press the OK button.

■ Resetting the Image Shift

Perform the following steps to reset the image shift adjustment.

Press the D.SHIFT/KEystone button twice to display the [D.Image Shift reset] window.

On the window, select [OK] with [\leftarrow], and then press the OK button.

Selecting Aspect Ratio

Select the aspect ratio of projecting image based on the input signal type, aspect ratio of the screen and resolution.

For more details on the aspect ratios, refer to "When Projecting an Image from a Computer" on page [135](#).

■ Types of Aspect Ratios

Auto

An image is projected at an aspect ratio of the input signal. Select this mode for normal image projection.



- [Auto] is not available if the input signal type is [VIDEO].
- [Auto] is automatically selected if the input signal type is [USB]. (SX80)

4:3

An image is projected at an aspect ratio of 4:3. Select this if an image of 4:3 aspect ratio cannot be appropriately projected in the [AUTO] mode.

16:9

An image is projected at an aspect ratio of 16:9. Select this if an image of 16:9 aspect ratio cannot be appropriately projected in the [AUTO] mode.

Zoom

An image with 4:3 aspect ratio is projected in the center of the screen enlarged in 16:9 aspect ratio with the upper and lower portion of the image cut off. Select this when projecting visual software having aspect ratio of 4:3 and black belts at the top and bottom of the image.

- This mode is available when you select [16:9] or [16:9 D. image shift] for [Screen aspect] and select [HDMI (576p, 480p) (SX80)], [COMPONENT (576p, 480p, 576i, 480i)], [VIDEO] or [S-VIDEO (SX80)] for input signal.

True size

An image is projected with the original resolution of the input signal. Select this to clearly project computer screen images having a resolution SXGA+ or lower (VGA, SVGA, XGA or SXGA) or visual software having a resolution lower than 1035i.

- This mode is available when you select [HDMI (720p, 576p, 480p) (SX80)] or [COMPONENT (720p, 576p, 480p)] for input signal.



- It is not available for an image having a resolution higher than SXGA+ or visual software having a resolution of 1080i, 1080p, 1035i, 576i or 480i.
- It is also available if the input signal is [ANALOG PC-1], [ANALOG PC-2], or [DIGITAL PC (SX80)]; however, it may not be available depending on the screen aspect setting.

■ How to Select an Aspect Ratio

Press the **ASPECT** button on the remote control to select an appropriate aspect ratio. The selection is toggled among types for aspect ratios by pressing the **ASPECT** button.

For more details on the aspect ratios, refer to "When Projecting an Image from a Computer" on page 135.

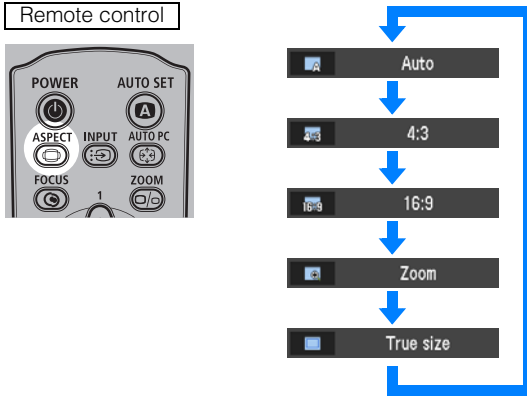

You can also select any aspect ratio from the menu. (P77)



Some aspect ratios may not appear depending on types of input signals.

Selecting an Image Mode

You can select an image mode depending on the projecting image. In each image mode, you can further adjust the brightness, contrast, sharpness, gamma, color adjustment, advanced adjustment, and lamp mode. (P89)

■ Image modes

Standard

Select this to project an image with near-original quality and a high regard for reproduction of white. It is suited to project text-based computer screens or visual software (moving pictures) in a bright room.

Presentation

Select this to project an image with quality suited for the presentation. It is also suited to project visual software (moving pictures) with a high regard for the brightness.

Movie

Select this to project common visual software (moving pictures). It is suited to easily enjoy the atmosphere of a moving theater in a dim room.

sRGB

Select this if you want to project an image in the display mode conforming to the sRGB standard (P140). It is suited to project an image shot by sRGB-compatible digital camera.

■ How to Select an Image Mode

Press the **IMAGE** button on the remote control to select your desired image mode. The selection is toggled among aspect types by pressing the button.

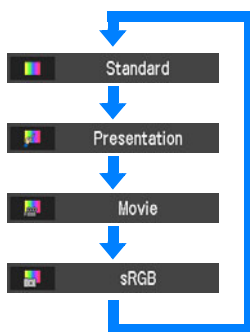

You can also select any image mode from the [Image mode] menu. (P89)

Turning Off the Projector

1 Press the **POWER** button to pop up a window shown at the lower right.

Remote control

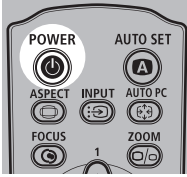

Top control

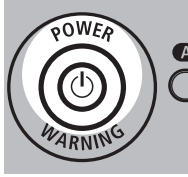

Press the **POWER** button again while the confirmation message is displayed. The lamp goes off, the [POWER] indicator starts flashing in red and the cooling fan starts.



- You cannot turn the projector on while the cooling fan is in operation.
- If you want to continue projecting, press a button other than **POWER** or wait until the confirmation message disappears.
- Wait at least 5 minutes before turning on the projector when you turn off the projector. It may shorten the lamp life if you turn on the projector immediately after turning it off.
- Using the projector for a long time may shorten the life of the lamp and internal optical components.

2 Remove the power cord from the AC outlet.

It continues to cool down the lamp even after removing the power cord. Thus, you may move or put away the projector immediately after the use.

With the power cord connected, the LED illumination lamp turns on during cooling cycle.

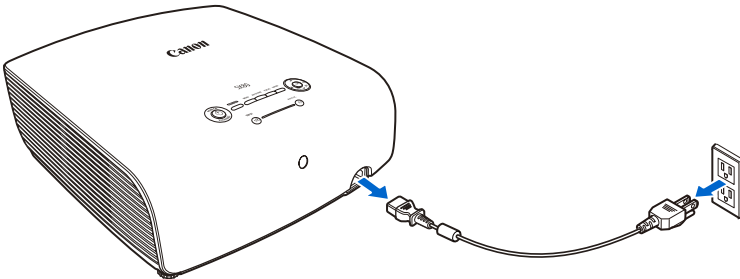

- Wait until the cooling fan stops before putting the projector in the carrying bag. Do not put the projector in the carrying bag until the cooling fan stops rotating. The projector may be damaged due to the heat.
- Attach the lens cap to the lens to protect it and put the projector in the carrying bag. Replace the adjustable foot to prevent the damage on the projector.

Useful Functions Available During a Presentation

Table of Contents

Safety Instructions

Before Use

Projecting an Image

Useful Functions Available During a Presentation

Setting Up Functions from Menus

Projecting an Image from a Digital Camera or an USB Flash Memory (SX80)

Connecting the Projector to Network (SX80)

Appendix

Index

Useful Functions Available During a Presentation

Blackened Out an Image Temporarily





Useful when:

- You finished the presentation.
- You want to divert attendees' attention from the screen.

Remote control



Press the  button to blacken out the image.

Press the  button again to show the image.

- You can set the screen state while blackening out the image on the menu. You can also set a specified image. (P87)
- The lamp keeps a turn-on state while blackening out the image.
- The (middle) LED illumination lamp on the top control flush slowly while blackening out the image.

Freezing the Picture



Useful when:

- You want to perform a computer operation which is irrelevant to the proceedings of the presentation.
- You want to stop a moving image.

Remote control

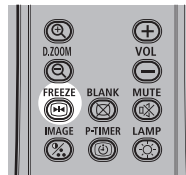

Press the  button to freeze the moving image. The projector shows the following icon.

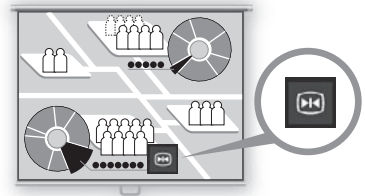

Press the  button again to cancel the FREEZE function.

- The (left and right) LED illumination lamps on the top control flushes slowly while stopping the image.
- It is cancelled once the input signal is terminated.
- You cannot zoom an image (P70) when you are freezing the image.

Adjusting the Volume



Useful when:

- You want to adjust the volume level of the projectors or external speaker.

Remote control



Press the  button. The following screen appears.

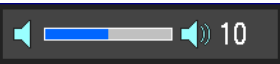

- You can also adjust the volume level with [$<$] / [$>$] of the projector.
- Adjust the volume or mute setting on the computer if the volume level is too low.
- You can also adjust the volume level of the speakers connected via the audio output terminal.

Muting the Sound



Useful when:

- You want to temporarily mute the unnecessary sound.
- You want to immediately mute the sound.

Remote control

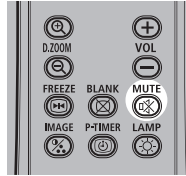

Press the  button to mute the sound. The projector shows the following icon.

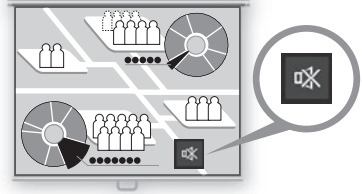

Press the  button again to cancel the MUTE function.

- You can also mute the sound of the speakers connected via the audio output terminal.

Zooming an Image



Useful when:

- Zoom in an object such as a small graph during a presentation (up to 12x).
- Focusing on the current subject.

Press the  button. A part of the image is enlarged each time pressed.

Remote control

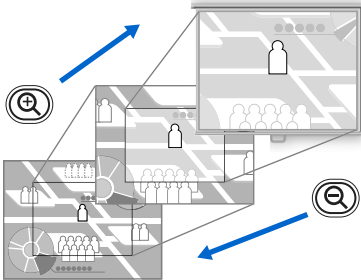

- The magnification appears on the screen.

You can move the area to the enlarged by using [\wedge] / [\vee] / [$<$] / [$>$].

Remote control

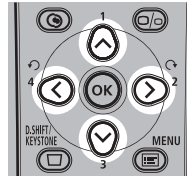

Projector

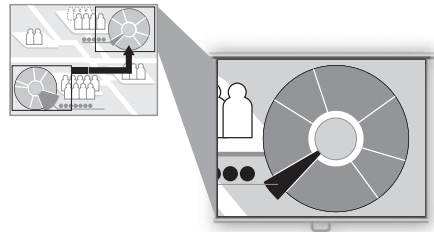
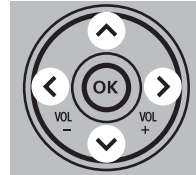

You can restore the original size of the image by pressing the  button.

Showing the Elapsed Time P-TIMER



Useful when:

- You want to manage the proceedings of the presentation.

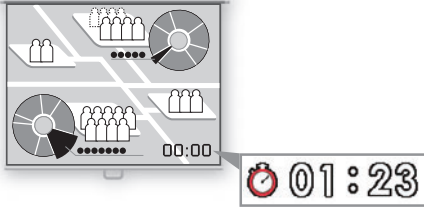



Press the  button to start counting.

- The elapsed time is displayed at the lower right corner of the screen.
- Time is counted up to 59:59. Then the timer returns to 00:00.

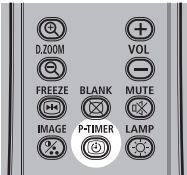
Remote control



Press the  button again to stop the timer.

- Press the  button while the timer is stopped. The timer disappears from the screen.

Then press the  button to start counting from 00:00.

Projecting Image Without Computer (SX80)

Useful when:

- You want to project an image from a digital camera.
- You want to project an image from USB flash memory.

You can project an image directly by connecting the projector with a PictBridge-compatible digital camera or USB flash memory.

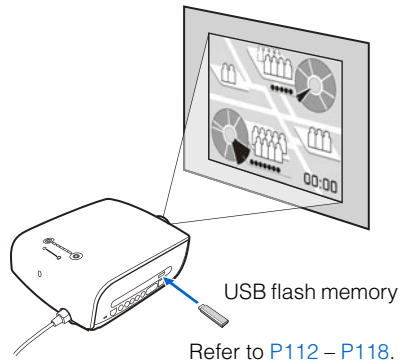
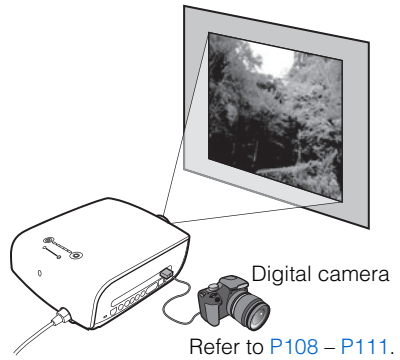

Setting Functions from Menus

Table of Contents

Safety Instructions

Before Use

Projecting an Image

Useful Functions Available During a Presentation

Setting Up Functions from Menus

Projecting an Image from a Digital Camera or an
USB Flash Memory (SX80)

Connecting the Projector to Network (SX80)

Appendix

Index

How to Use Menu

With a menu, you can set the operation of the projector in detail.

■ Menu Configuration

The menu screen is divided into four tabs as follows:

 [Display settings] tab (P77)
You can set the type of signal or the method of projection of the images input.

 [System settings] tab (P97)
You can set the operation of the projector.

 [Image adjustment] tab (P89)
You can adjust the image quality and colors as you like.

 [Information] tab (P106)
You can confirm the information about the signal types of the images projected and other projector-specific information.

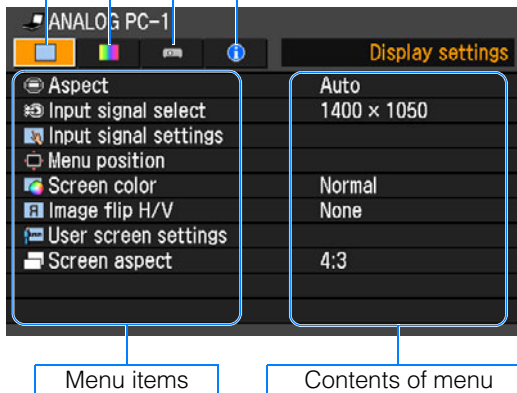

Input Signal Types for which a Menu Item is Displayed

Different menu items are displayed for different input signal types.

In the following explanation of each menu item, the input signal type for which the menu item is displayed is indicated as follows:

The following is for SX80.

- Input signal for which the menu item is displayed
- Input signal for which the menu item is not displayed

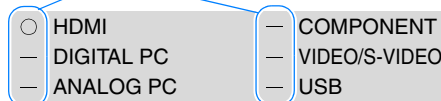

Basic Operation of Menu

1 Press the MENU button to display a menu window.

Remote control

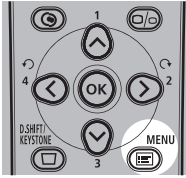

Top control

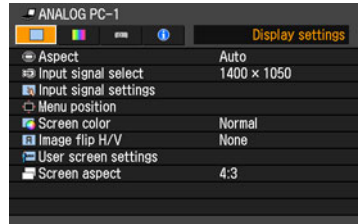
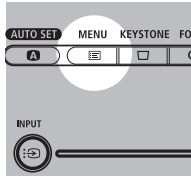

2 Use [←] / [→] to select a tab.

Remote control

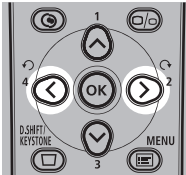

Top control

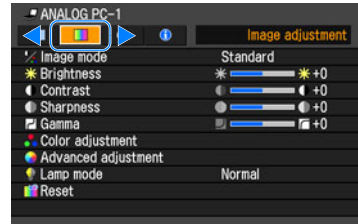
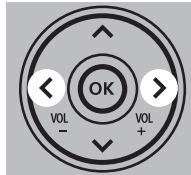

- If the tab position is not highlighted in orange, use [↑] / [↓] to move the highlight to the top.

3 Use [↑] / [↓] to select an item.

Remote control

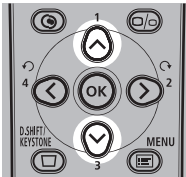

Top control

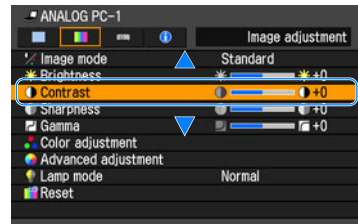
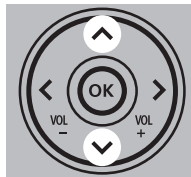

4 Select contents.

How to select the contents varies depending on items.

Selection from a list Example: Aspect

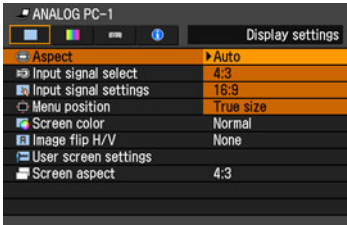

1. Press the **OK** button or [**>**], and a list of the contents is displayed.
2. Use [**^**] / [**v**] to select contents.
3. If you found the contents you desired, press the **OK** button or [**>**].

With [**<**] / [**>**] Example: Contrast



Use [**<**] / [**>**] to change the adjustment volume.

In a different screen (1) Example: Menu position

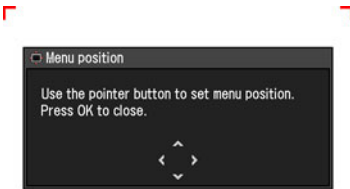

1. Press the **OK** button to display a different screen.
2. The follow the instruction on the screen.

In a different screen (2) Example: Tracking

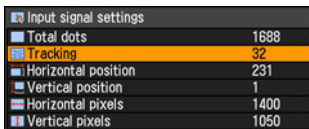

1. Press the **OK** button to display a different screen.
2. Use [**^**] / [**v**] to select contents, and use [**<**] / [**>**] to select a value.
3. If you found the contents you desired, press the **OK** button.

5 Press the MENU button, and the menu screen disappears.

Setting Display Status

Selecting an Image Projection Mode

[Aspect]

- | | |
|----------------------------------|-------------------------------------|
| <input type="radio"/> HDMI | <input type="radio"/> COMPONENT |
| <input type="radio"/> DIGITAL PC | <input type="radio"/> VIDEO/S-VIDEO |
| <input type="radio"/> ANALOG PC | <input type="radio"/> USB |



You can select a projection mode corresponding to the aspect ratio of image.

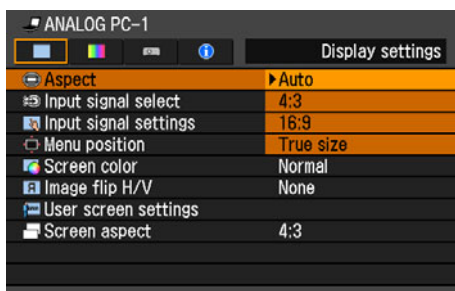

- Different contents are displayed for different screen aspects or input signal types.
- The **ASPECT** button on the remote control can also be used to select the Aspect settings.

Auto	An image is projected at an aspect ratio of the input signal. Select this mode for normal image projection.
4:3	An image is projected at an aspect ratio of 4:3. Select this if an image of 4:3 aspect ratio cannot be appropriately projected in the [AUTO] mode.
16:9	An image is projected at an aspect ratio of 16:9. Select this if an image of 16:9 aspect ratio cannot be appropriately projected in the [AUTO] mode.

Zoom An image with 4:3 aspect ratio is projected in the center of the screen enlarged in 16:9 aspect ratio with the upper and lower portion of the image cut off. Select this when projecting visual software having aspect ratio of 4:3 and black belts at the top and bottom of the image.

- This mode is available when you select [16:9] or [16:9 D. image shift] for [Screen aspect] and select [HDMI (576p, 480p) (SX80)], [COMPONENT (576p, 480p, 576i, 480i)], [VIDEO] or [S-VIDEO (SX80)] for input signal.

True size An image is projected with the original resolution of the input signal. Select this to clearly project computer screen images having a resolution SXGA+ or lower (VGA, SVGA, XGA or SXGA) or visual software having a resolution lower than 1035i.

- This mode is available when you select [HDMI (720p, 576p, 480p) (SX80)] or [COMPONENT (720p, 576p, 480p)] for input signal.
- It is not available for an image having a resolution higher than SXGA+ or visual software having a resolution of 1080i, 1080p, 1035i, 576i or 480i.
- It is also available if the input signal is [ANALOG PC-1], [ANALOG PC-2], or [DIGITAL PC (SX80)]; however, it may not be available depending on the screen aspect setting.

Press the **OK** button to accept your setting and then press the **MENU** button.

- ! [Auto] and [True size] are not available if the input signal type is [VIDEO].
- [Auto] is automatically selected if the input signal type is [USB]. (SX80)

Selecting an Input Signal Type (ANALOG PC)

[Input signal select]

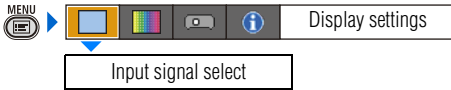

You can select a proper resolution if auto PC adjustment function (P55) cannot project a correct image from a computer.

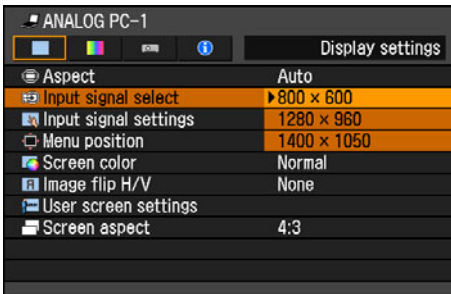

Press the **OK** button to accept your setting and then press the **MENU** button.

Select an input signal corresponding to the resolution of the computer.

- For the signal types supported by the projector, see the table on page 138.

Selecting an Input Signal Type (VIDEO/S-VIDEO*)

[Input signal select]

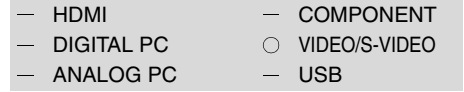

* is only applicable to SX80

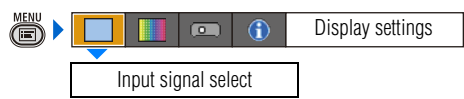

You can select a proper signal type if a video image from your AV equipment is not projected correctly.

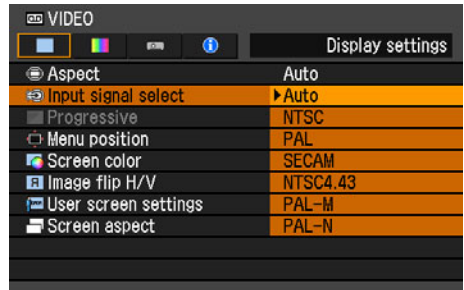

Press the **OK** button to accept your setting and then press the **MENU** button.

- [Auto] is the factory default.
- Refer to the User's Manual of your AV equipment connected to the projector to confirm the input signal type.

Selecting an Input Signal Type (COMPONENT)

[Input signal select]

— HDMI	○ COMPONENT
— DIGITAL PC	— VIDEO/S-VIDEO
— ANALOG PC	— USB

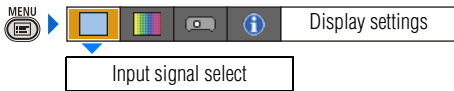

You can select a proper component signal type, if a video image from AV equipment is not projected correctly.

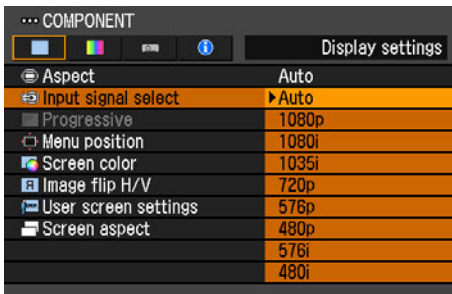

Press the **OK** button to accept your setting and then press the **MENU** button.

- [Auto] is the factory default.
- Refer to the User's Manual of your AV equipment connected to the projector to confirm the component signal type.

Adjusting Input Signal (ANALOG PC) – Total Dots

[Input signal settings] - [Total dots]

— HDMI	— COMPONENT
— DIGITAL PC	— VIDEO/S-VIDEO
○ ANALOG PC	— USB

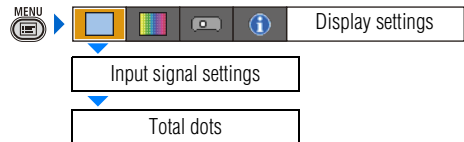

You can adjust the total number of dots in the horizontal direction. Adjust it when stripes are displayed on the screen.

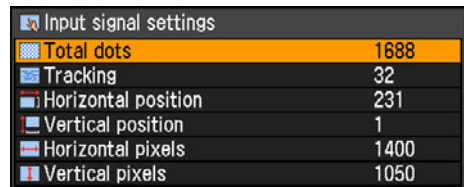

Use [**<**] / [**>**] to select a value. When you have completed the adjustment, press the **MENU** button.

- Perform this adjustment if the [AUTO PC] function (P55) cannot adjust the project image correctly.
- You can make adjustment either for [ANALOG PC-1] or [ANALOG PC-2].

Adjusting Input Signal (ANALOG PC) – Tracking

[Input signal settings] - [Tracking]

— HDMI	— COMPONENT
— DIGITAL PC	— VIDEO/S-VIDEO
<input type="radio"/> ANALOG PC	— USB

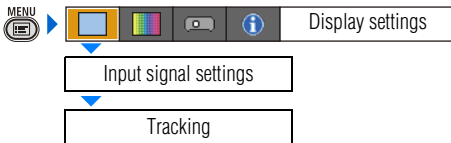

You can fine-tune the timing for generating an image from the image signal. Adjusts the tracking when the image distorts or flickers.

Input signal settings	
Total dots	1688
Tracking	32
Horizontal position	231
Vertical position	1
Horizontal pixels	1400
Vertical pixels	1050

Use [$<$] / [$>$] to select a value. When you have completed the adjustment, press the **MENU** button.

- Perform this adjustment if the [AUTO PC] function (P55) cannot adjust the project image correctly.
- You can make adjustment either for [ANALOG PC-1] or [ANALOG PC-2].

Adjust Input Signal (ANALOG PC) – Horizontal position

[Input signal settings] - [Horizontal position]

— HDMI	— COMPONENT
— DIGITAL PC	— VIDEO/S-VIDEO
<input type="radio"/> ANALOG PC	— USB

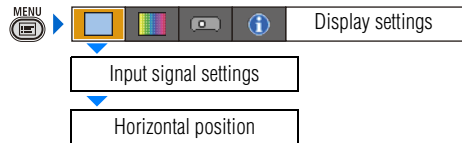

You can adjust the horizontal position of the screen when the projected image is shifted in the horizontal direction.

Input signal settings	
Total dots	1688
Tracking	32
Horizontal position	231
Vertical position	1
Horizontal pixels	1400
Vertical pixels	1050

Use [$<$] / [$>$] to select a value. As the value increases, the screen moves to the left.

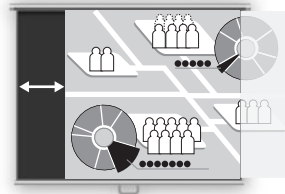

When you have completed the adjustment, press the **MENU** button.

- Perform this adjustment if the [AUTO PC] function (P55) cannot adjust the project image correctly.
- You can make adjustment either for [ANALOG PC-1] or [ANALOG PC-2].

Adjust Input Signal (ANALOG PC) – Vertical position

[Input signal settings] - [Vertical position]

— HDMI	— COMPONENT
— DIGITAL PC	— VIDEO/S-VIDEO
<input type="radio"/> ANALOG PC	— USB

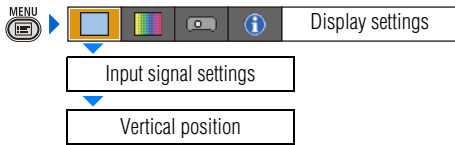

You can adjust the vertical position of the screen when the projected image is shifted in the vertical direction.

Input signal settings	
Total dots	1688
Tracking	32
Horizontal position	231
Vertical position	1
Horizontal pixels	1400
Vertical pixels	1050

Use [$<$] / [$>$] to select a value. As the value increases, the screen moves upward.

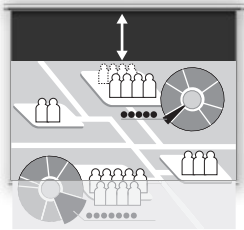

When you have completed the adjustment, press the **MENU** button.

- Perform this adjustment if the [AUTO PC] function (P55) cannot adjust the project image correctly.
- You can make adjustment either for [ANALOG PC-1] or [ANALOG PC-2].

Adjust Input Signal (ANALOG PC) – Horizontal pixels

[Input signal settings] - [Horizontal pixels]

— HDMI	— COMPONENT
— DIGITAL PC	— VIDEO/S-VIDEO
<input type="radio"/> ANALOG PC	— USB

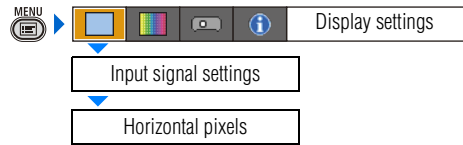

You can adjust the number of the pixels in the horizontal direction if the length of the screen is too long or too short in the horizontal direction.

Input signal settings	
Total dots	1688
Tracking	32
Horizontal position	231
Vertical position	1
Horizontal pixels	1400
Vertical pixels	1050

Use [$<$] / [$>$] to select a value.

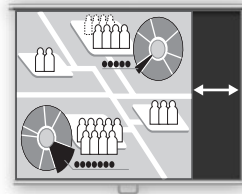

When you have completed the adjustment, press the **MENU** button.

- Perform this adjustment if the [AUTO PC] function (P55) cannot adjust the project image correctly.
- You can make adjustment either for [ANALOG PC-1] or [ANALOG PC-2].

Adjust Input Signal (ANALOG PC) – Vertical pixels

[Input signal settings] - [Vertical pixels]

- HDMI
- DIGITAL PC
- ANALOG PC
- COMPONENT
- VIDEO/S-VIDEO
- USB

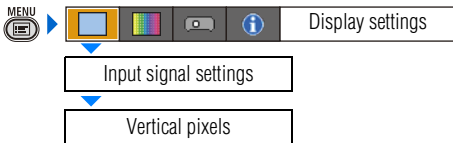

You can adjust the number of the pixels in the vertical direction if the length of the screen is too long or too short in the vertical direction.

Input signal settings	
Total dots	1688
Tracking	32
Horizontal position	231
Vertical position	1
Horizontal pixels	1400
Vertical pixels	1050

Use [$<$] / [$>$] to select a value.

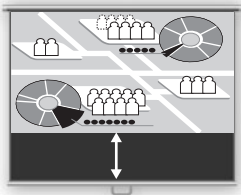

When you have completed the adjustment, press the **MENU** button.

- Perform this adjustment if the [AUTO PC] function (P55) cannot adjust the project image correctly.
- You can make adjustment either for [ANALOG PC-1] or [ANALOG PC-2].

Selecting HDMI Input Level (SX80)

[HDMI input level]

- HDMI
- DIGITAL PC
- ANALOG PC
- COMPONENT
- VIDEO/S-VIDEO
- USB



You can select this as required when you project visual software with the HDMI signals.

HDMI	
Aspect	Auto
HDMI input level	Auto
HDMI over scan	Normal
Progressive	Expanded
Menu position	
Screen color	Normal
Image flip H/V	None
User screen settings	
Screen aspect	4:3

Press the **OK** button to accept your setting and then press the **MENU** button.

- [Auto] is the factory default.
- You can select this only when the type of signal sent from AV equipment is RGB.
- The signal level is select automatically in [Auto] mode. (Some AV equipment may not support this.)
- If the HDMI output of your AV equipment allows switching between [Normal] and [Expanded], we recommend you to set [Expanded]. The contrast of images will be improved and dark scenes will be rendered more realistically. In this case, select [Auto] or [Expanded] for the HDMI input level.

For more detailed information, refer to the User's Manual of your AV equipment connected to the projector.

Select HDMI Over Scan (SX80)

[HDMI over scan]

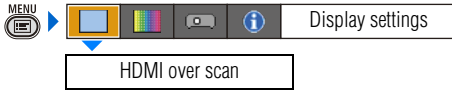

You can select this as required when you project visual software with the HDMI signals.

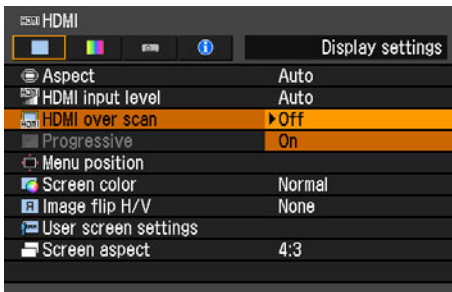

- Off** The entire input signals (100%) are projected. The images projected may be smaller than the full projection screen.
- On** Images are projected with disorders at their peripheral section of images trimmed off. (The central 95% of the images are projected.) A part of peripheral sections of images may be cut out depending on the resolution of the signals. In such a case, select [Off].

Press the **OK** button to accept your setting and then press the **MENU** button.

- [On] is the factory default.

Performing Progressive Processing

[Progressive]



You can select this as required when the images have low resolution.

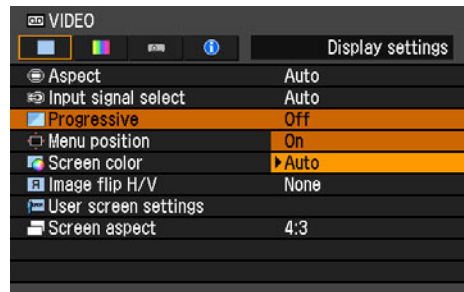

- Off** Do not perform the progressive processing.
- On** Performs the progressive processing. This mode is available when the HDMI signal is 1080i or, VIDEO/S-VIDEO or COMPONENT signal is 1080i, 1035i, 576i, or 480i.
- Auto** Performs the appropriate progressive processing according to the input signal.

Press the **OK** button to accept your setting and then press the **MENU** button.

- [Auto] is the factory default.
- You can set this mode for either [HDMI (SX80)], [COMPONENT], [VIDEO] or [S-VIDEO (SX80)].
- Select [Off] when flickers and horizontal lines are noticeable on a fast-moving picture.
- For the details of the progressive processing, refer to the page [142](#).

Selecting a Menu Position

[Menu position]

- | | |
|----------------------------------|-------------------------------------|
| <input type="radio"/> HDMI | <input type="radio"/> COMPONENT |
| <input type="radio"/> DIGITAL PC | <input type="radio"/> VIDEO/S-VIDEO |
| <input type="radio"/> ANALOG PC | <input type="radio"/> USB |



You can change the position of menu displayed.

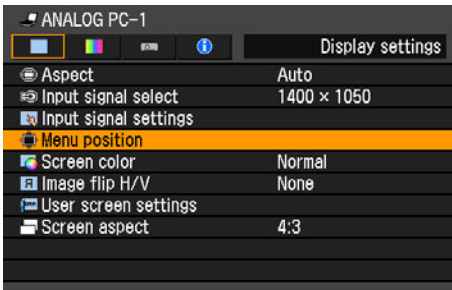

Move the menu to the desired position with [\wedge] / [\lt] / [\vee] / [\gt].



When the menu has been moved to the desired position, press the **OK** or **MENU** button.

Correcting the Screen Color

[Screen color]

- | | |
|----------------------------------|-------------------------------------|
| <input type="radio"/> HDMI | <input type="radio"/> COMPONENT |
| <input type="radio"/> DIGITAL PC | <input type="radio"/> VIDEO/S-VIDEO |
| <input type="radio"/> ANALOG PC | <input type="radio"/> USB |



You can adjust the color quality of the images projected corresponding to the color of the projection screen.

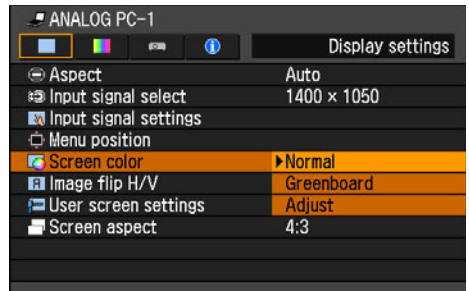

Normal Select this if a standard type of projection screen is used. The images are projected in the light quality similar to that of natural light.

Greenboard Select this if a greenboard (in dark green color) is used for the projection screen. The color quality similar to [Normal] is obtained on the greenboard.

Adjust Select this if you make detailed adjustment. The following popup screen will appear.

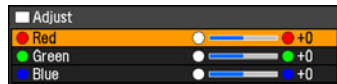

Use [\wedge] / [\vee] to select a primary color. [\gt] makes the color selected darker. [\lt] makes the color selected lighter. Press the **AUTO SET** button while the screen is displayed if you want to perform the auto color correction. (SX80)

Press the **OK** button to accept your setting and then press the **MENU** button.

- [Normal] is the factory default.

Reversing projection

[Image flip H/V]

- | | |
|----------------------------------|-------------------------------------|
| <input type="radio"/> HDMI | <input type="radio"/> COMPONENT |
| <input type="radio"/> DIGITAL PC | <input type="radio"/> VIDEO/S-VIDEO |
| <input type="radio"/> ANALOG PC | <input type="radio"/> USB |



You can make this setting if you want to hang the projector from the ceiling or project an image from behind the screen.

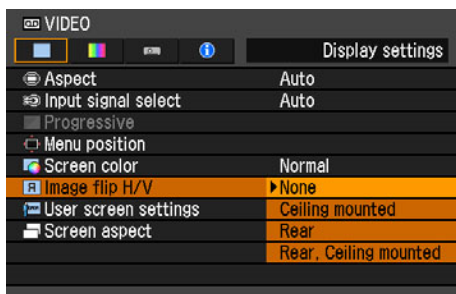

None	Select this if you project an image normally.
Ceiling mounted	Select this if you project an image with the projector hung from the ceiling. The projected images is inverted in both vertical and horizontal directions.
Rear	Select this if you project an image from behind the screen. The projected images is inverted in the horizontal direction.
Rear, Ceiling mounted	Select this if you project an image from behind the screen with the projector hung from the ceiling. The projected image is inverted in the vertical direction.

Press the **OK** button to accept your setting and then press the **MENU** button.

- [None] is the factory default.

None (Normal image)

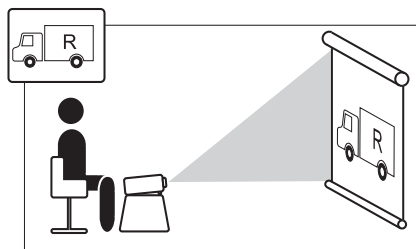

Ceiling mounted

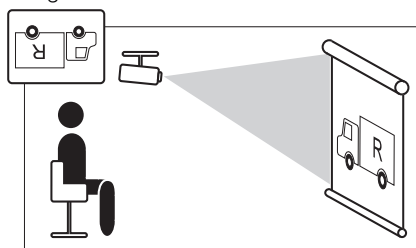

Rear

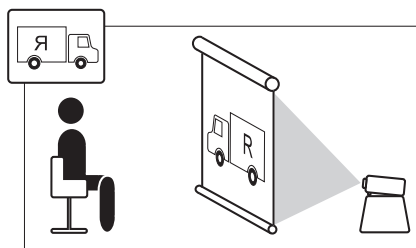

Rear, Ceiling mounted

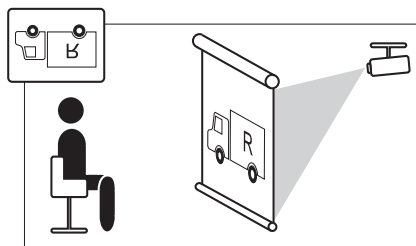

- To hang the projector from the ceiling, use the optional bracket. Contact your Canon dealer.
- The keystone distortion adjustment will be reset.

Capturing a Logo

[User screen settings] - [Logo capture]

- HDMI
- DIGITAL PC
- ANALOG PC
- COMPONENT
- VIDEO/S-VIDEO
- USB

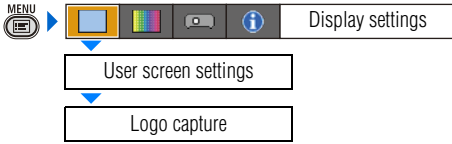

You can capture a part of the images being projected as [User logo].

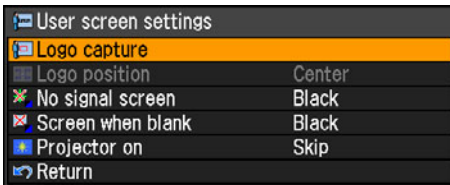

A screen for capturing images is displayed.

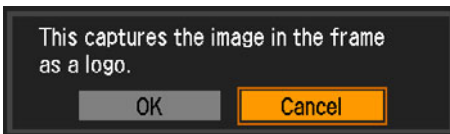

OK Press the **OK** button, and the image in the red frame is captured as [User logo].

Cancel Cancels the image capturing.

- For projecting the captured log on a screen, select [User logo] on the [Projector on], [No signal screen], [Screen when blank].
- You may not capture an image depending on the resolution and scan system.
- You cannot capture an image when [16:9] or [16:9 D. image shift] is selected for [Screen aspect].

Selecting the User Logo Display Position

[User screen settings] - [Logo position]

- HDMI
- DIGITAL PC
- ANALOG PC
- COMPONENT
- VIDEO/S-VIDEO
- USB

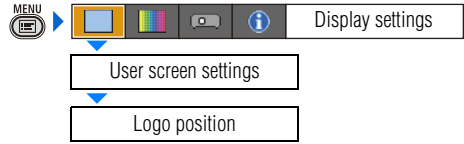

You can select a log display position.

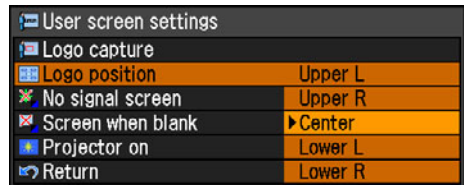

Upper L Select a position you want to display a user logo and press the **OK** button.

Upper R

Center

Lower L

Lower R

Press the **OK** button to accept your setting and then press the **MENU** button.

- [Center] is the factory default.
- You cannot select [Logo position] if you have not captured a user logo on the [Logo capture] screen.

No Signal Screen

[User screen settings] - [No signal screen]

- | | |
|----------------------------------|-------------------------------------|
| <input type="radio"/> HDMI | <input type="radio"/> COMPONENT |
| <input type="radio"/> DIGITAL PC | <input type="radio"/> VIDEO/S-VIDEO |
| <input type="radio"/> ANALOG PC | <input type="radio"/> USB |

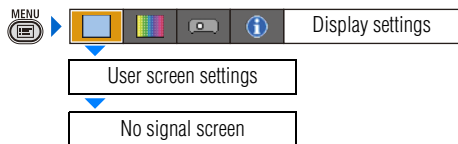

You can display a user logo on a screen when there is no input signal.

User screen settings	
Logo capture	
Logo position	Center
No signal screen	Black
Screen when blank	Blue
Projector on	User logo
Return	

Black	The screen is all black. Displays no user logo.
Blue	The screen is blue background. Displays no user logo.
User logo	Displays a user logo.

Press the **OK** button to accept your setting and then press the **MENU** button.

- [Blue] is the factory default.
- [User logo] is available only when a user's logo has been registered.

Screen When Blank

[User screen settings] - [Screen when blank]

- | | |
|----------------------------------|-------------------------------------|
| <input type="radio"/> HDMI | <input type="radio"/> COMPONENT |
| <input type="radio"/> DIGITAL PC | <input type="radio"/> VIDEO/S-VIDEO |
| <input type="radio"/> ANALOG PC | <input type="radio"/> USB |

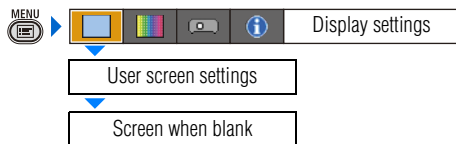

You can display a user logo a screen when the projected image is blacked out temporarily by pressing the **BLANK** button on the remote control.

User screen settings	
Logo capture	
Logo position	Center
No signal screen	Black
Screen when blank	Black
Projector on	Blue
Return	User logo

Black	The screen is all black. Displays no user logo.
Blue	The screen is blue background. Displays no user logo.
User logo	Displays a user logo.

Press the **OK** button to accept your setting and then press the **MENU** button.

- [Black] is the factory default.
- [User logo] is available only when a user's logo has been registered.

Selecting a Logo at Startup

[User screen settings] - [Projector on]

- | | |
|----------------------------------|-------------------------------------|
| <input type="radio"/> HDMI | <input type="radio"/> COMPONENT |
| <input type="radio"/> DIGITAL PC | <input type="radio"/> VIDEO/S-VIDEO |
| <input type="radio"/> ANALOG PC | <input type="radio"/> USB |

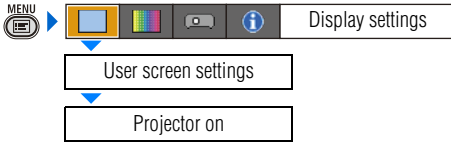

You can display a specified logo on a screen from the moment the projector is turned on to the moment it is ready for projection.

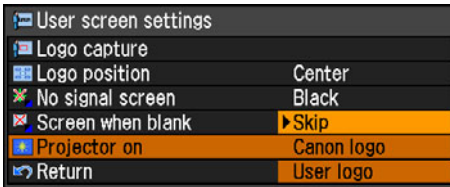

Skip	Projects an input signal immediately after turning on the projector.
Canon logo	Displays the Canon logo captured at the factory.
User logo	Displays a user logo captured on the [Logo capture] screen.

Press the **OK** button to accept your setting and then press the **MENU** button.

- [Canon logo] is the factory default.
- [User logo] is available only when a user's logo has been registered.

Selecting Aspect Ratio of Screen

[Screen aspect]

- | | |
|----------------------------------|-------------------------------------|
| <input type="radio"/> HDMI | <input type="radio"/> COMPONENT |
| <input type="radio"/> DIGITAL PC | <input type="radio"/> VIDEO/S-VIDEO |
| <input type="radio"/> ANALOG PC | <input type="radio"/> USB |



You can select proper option corresponding to the aspect ratio of the projecting screen.

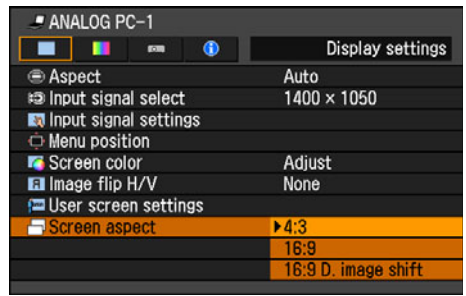

4:3	Select this when you use a screen with aspect ratio of 4:3. You can adjust the keystone distortion with D.SHIFT/KEYSTONE button.
16:9	Select this when you use a screen with aspect ratio of 16:9. You can adjust the keystone distortion with D.SHIFT/KEYSTONE button.
16:9 D. image shift	Select this when you use a screen with aspect ratio of 16:9. You can move the screen upward or downward with D.SHIFT/KEYSTONE button.

Press the **OK** button to accept your setting and then press the **MENU** button.

- [4:3] is the factory default.
- If you select [16:9 D. image shift], the keystone adjustment will be reset. For more details, refer to the page 61.
- [Auto] may be automatically selected for [Screen aspect] depending on the screen aspect setting.

Setting the Image Quality

Selecting an Image Quality

[Image mode]

- | | |
|----------------------------------|-------------------------------------|
| <input type="radio"/> HDMI | <input type="radio"/> COMPONENT |
| <input type="radio"/> DIGITAL PC | <input type="radio"/> VIDEO/S-VIDEO |
| <input type="radio"/> ANALOG PC | <input type="radio"/> USB |

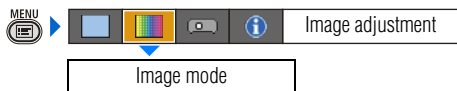

You can select an image mode suitable for the projecting image.

You can select it also with the **IMAGE** button on the remote control.

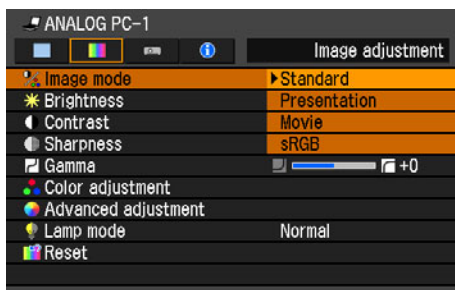

Press the **OK** button to accept your setting and then press the **MENU** button.

- [Standard] is the factory default.
- You can decide the image quality by adjusting the following items in each image mode:
[Brightness], [Contrast], [Sharpness], [Gamma], [Color adjustment], [Advanced adjustment] and [Lamp mode].
- The adjustment you have made is stored as each combination of input signals and an image mode.

-
- | | |
|---------------------|---|
| Standard | Select this to project an image with near-original quality and a high regard for reproduction of white. It is suited to showing a computer screen or watching visual software (moving pictures) in a bright room. |
| Presentation | Select this to project an image with quality suited for the presentation. It is also suited to project visual software (moving pictures) with a high regard for the brightness. |
| Movie | Select this to project moving pictures of all kinds. Its brightness is suited to easily enjoy the atmosphere of a movie theatre in a dim room. |
| sRGB | Select this if you want to project an image in the display mode conforming to the sRGB standard (P140). It is suited to project an image shot by sRGB-compatible digital camera. |
-

Adjusting the Brightness

[Brightness]

- | | |
|----------------------------------|-------------------------------------|
| <input type="radio"/> HDMI | <input type="radio"/> COMPONENT |
| <input type="radio"/> DIGITAL PC | <input type="radio"/> VIDEO/S-VIDEO |
| <input type="radio"/> ANALOG PC | <input type="radio"/> USB |



You can adjust the brightness of images.

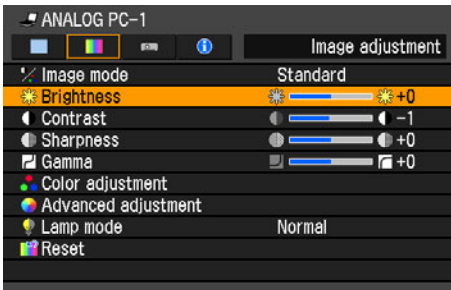

[>] Increases the brightness of an image.

[<] Decreases the brightness of an image.

When you have completed the adjustment, press the **MENU** button.

- The adjustment you have made is stored as an adjusted value of input signals being projected in an image mode.

Adjusting the Contrast

[Contrast]

- | | |
|----------------------------------|-------------------------------------|
| <input type="radio"/> HDMI | <input type="radio"/> COMPONENT |
| <input type="radio"/> DIGITAL PC | <input type="radio"/> VIDEO/S-VIDEO |
| <input type="radio"/> ANALOG PC | <input type="radio"/> USB |



You can adjust the contrast of images.

If you want to make it more or less vivid, adjust the difference in tone between the lightest and darkest portions of the image.

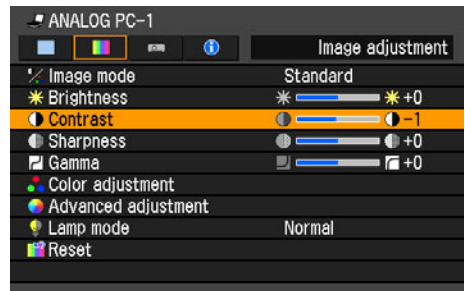

[>] Increases the contrast of an image. It emphasizes the darker portion and the bright portion on the projected image.

[<] Decreases the contrast of an image. The image becomes less vivid.

When you have completed the adjustment, press the **MENU** button.

- The adjustment you have made is stored as an adjusted value of input signals being projected in an image mode.

Adjusting the Sharpness

[Sharpness]

- | | |
|----------------------------------|-------------------------------------|
| <input type="radio"/> HDMI | <input type="radio"/> COMPONENT |
| <input type="radio"/> DIGITAL PC | <input type="radio"/> VIDEO/S-VIDEO |
| <input type="radio"/> ANALOG PC | <input type="radio"/> USB |



You can adjust the sharpness of images.

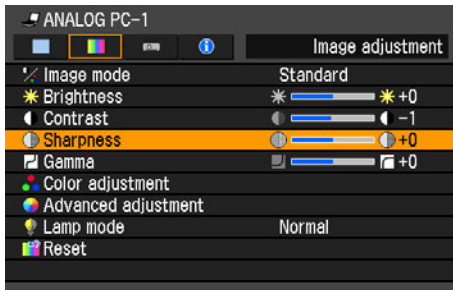

[>] Increases the sharpness of an image.

[<] Decreases the sharpness of an image.

When you have completed the adjustment, press the **MENU** button.

- The adjustment you have made is stored as an adjusted value of input signals being projected in an image mode.

Making a Gamma Correction

[Gamma]

- | | |
|----------------------------------|-------------------------------------|
| <input type="radio"/> HDMI | <input type="radio"/> COMPONENT |
| <input type="radio"/> DIGITAL PC | <input type="radio"/> VIDEO/S-VIDEO |
| <input type="radio"/> ANALOG PC | <input type="radio"/> USB |

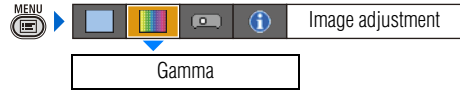

You can correct the obscure portion of an image due to too dark or bright.

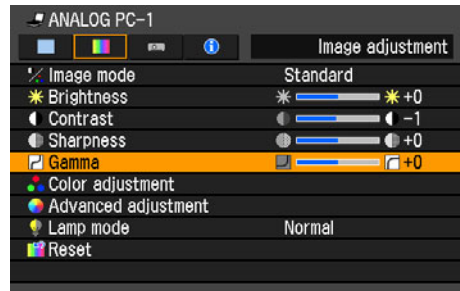

[>] Brighten the dark portion.

[<] Darken the bright portion.

When you have completed the adjustment, press the **MENU** button.

- The adjustment you have made is stored as an adjusted value of input signals being projected in an image mode.
- For the details of the gamma correction, refer to the page [142](#).

Making Color Adjustment (HDMI*/Digital PC*/Analog PC/USB*)

[Color adjustment]

- HDMI
- DIGITAL PC
- ANALOG PC
- COMPONENT
- VIDEO/S-VIDEO
- USB

* is only applicable to SX80

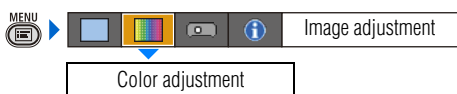

You can adjust the color quality of images for each of primary colors, red, green and blue.



R/G/B Gain Adjust the intensity of each color.
 [>] Increases the color intensity.
 [<] Decreases the color intensity.

R/G/B Offset Adjusts the color reproducibility of dark portions of each color.
 [>] Increases the color reproducibility of color.
 [<] Decreases the color reproducibility of color.

When you have completed the adjustment, press the **MENU** button.

- The adjustment you have made is stored as an adjusted value of input signals being projected in an image mode.
- Adjusting a color makes mark shown in [Color adjustment] in the menu.



Making Color Adjustment (COMPONENT/VIDEO/S-VIDEO*)

[Color adjustment]

- HDMI
- DIGITAL PC
- ANALOG PC
- COMPONENT
- VIDEO/S-VIDEO
- USB

* is only applicable to SX80

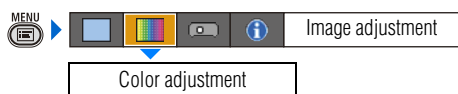

You can adjust the color depth and hue of images for each of primary colors, red, green and blue.



Color level Adjusts the intensity of each color.
 [>] Increases the intensity of color.
 [<] Decreases the intensity of color.

Color balance Adjusts the color balance of a reddish or greenish image.
 [>] Corrects a reddish image.
 [<] Corrects a greenish image.

R/G/B Gain The same as "Making Color Adjustment (HDMI/Digital PC/ Analog PC/USB)".

R/G/B Offset The same as "Making Color Adjustment (HDMI/Digital PC/ Analog PC/USB)".

When you have completed the adjustment, press the **MENU** button.

- You cannot adjust the color balance in [Video] except NTSC.
- The adjustment you have made is stored as an adjusted value of input signals being projected in an image mode.

Making Advanced Adjustment (Noise reduction)

[Advanced adjustment] - [Noise reduction]

- HDMI
- COMPONENT
- DIGITAL PC
- VIDEO/S-VIDEO
- ANALOG PC
- USB

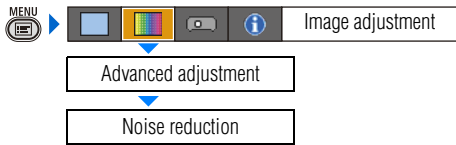

You can reduce noise of picture.



- Off** Disables noise reduction.
- Weak** Select this option for noisy picture.
- Strong** Select this option for excessively noisy picture.

Press the **OK** button to accept your setting and then press the **MENU** button.

- [Off] is the factory default.
- Noise reduction may produce an after-image for quick footage.
- Select [Weak] for quick footage. Select [Strong] for slow footage.
- The setting you have made is stored as a setting value of input signals being projected in an image mode.
- Making this setting makes mark shown in [Advanced adjustment] in the menu.

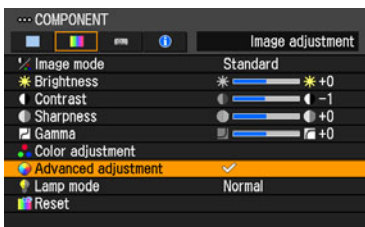

Making Advanced Adjustment (Dynamic gamma)

[Advanced adjustment] - [Dynamic gamma]

- HDMI
- COMPONENT
- DIGITAL PC
- VIDEO/S-VIDEO
- ANALOG PC
- USB

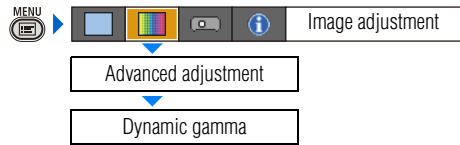

You can adjust the gradation representation of light and dark portions of an image automatically.

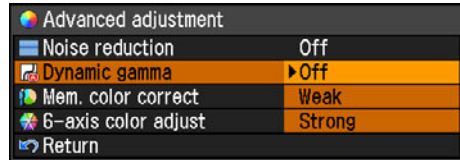

- Off** Dynamic gamma is disabled.
- Weak** Dynamic gamma is used a little.
- Strong** Dynamic gamma is used to a large extent.

Press the **OK** button to accept your setting and then press the **MENU** button.

- [Off] is the factory default.
- The adjustment you have made is stored as an adjusted value of input signals being projected in an image mode.

Making Advanced Adjustment (Mem. color correct) (SX80)

[Advanced adjustment] - [Mem. color correct]

- HDMI
- DIGITAL PC
- ANALOG PC
- COMPONENT
- VIDEO/S-VIDEO
- USB

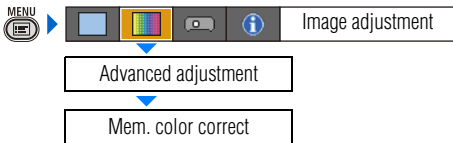

You can correct colors (e.g. blue sky, field of grass, skin) in our memory so that they can be projected more vividly.

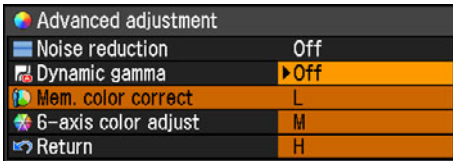

- Off** Disables the memorized color correction function.
- L** Specifies the intensity of the memorized color correction in three steps.
- M**
- H**

Press the **OK** button to accept your setting and then press the **MENU** button.

- [Off] is the factory default.
- The adjustment you have made is stored as an adjusted value of input signals being projected in an image mode.
- For the details of the memorized color correction, refer to the page [142](#).

Making Advanced Adjustment (Auto fleshtone) (SX800)

[Advanced adjustment] - [Auto fleshtone]

- ANALOG PC
- COMPONENT
- VIDEO

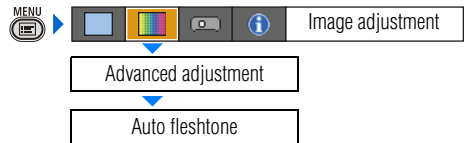

You can represent the skin color impressively.



- Off** Disables the [Auto fleshtone] function.
- L** Specifies the intensity of the [Auto fleshtone] in three steps.
- M**
- H**

Press the **OK** button to accept your setting and then press the **MENU** button.

- The adjustment you have made is stored as an adjusted value of input signals being projected in an image mode.

Adjusting Fine Color Adjustment (6-axis color adjust) (SX80)

[Advanced adjustment] - [6-axis color adjust]

- HDMI
- DIGITAL PC
- ANALOG PC
- COMPONENT
- VIDEO/S-VIDEO
- USB

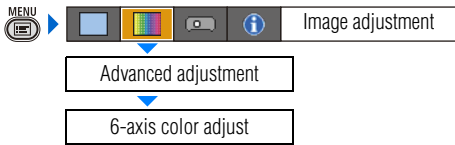

You can make fine color adjustment with RGB (red, green, blue) and CMY (cyan, magenta, yellow). For the details of 6-axis color adjust, refer to the page 143.

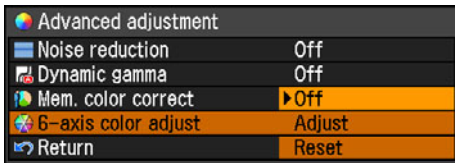

Off Disables the 6-axis color adjustment. If you select [Adjust], the previous setting of 6-axis color adjustment becomes active again.

Adjust Enables the 6-axis color adjustment.

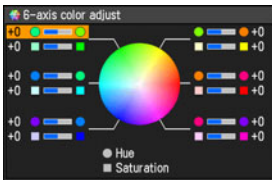

Use [^] / [v] to select [○ Hue] or [□ Saturation], then adjust them with [<] / [>].

Reset Returns any adjustment values to zero.

When you have completed the adjustment, press the **MENU** button.

- [Off] is the factory default.
- The adjustment you have made is stored as an adjusted value of input signals being projected in an image mode.

Reducing the Lamp Brightness

[Lamp mode]

- HDMI
- DIGITAL PC
- ANALOG PC
- COMPONENT
- VIDEO/S-VIDEO
- USB

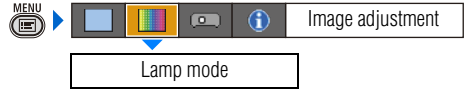

Reducing the lamp brightness reduces power consumption and cooling fan noise. You can enable or disable this mode also with the **LAMP** button on the remote control.

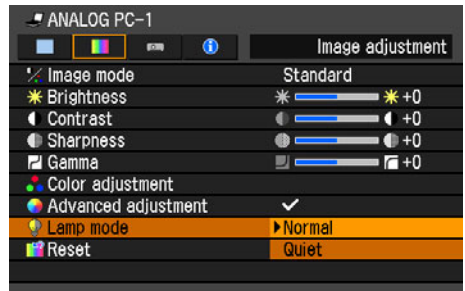

Normal Projects an image at the normal brightness level.

Quiet Reduces the lamp brightness and cooling fan noise.

Press the **OK** button to accept your setting and then press the **MENU** button.

- [Normal] is the factory default.
- The setting you have made is stored as a setting value of input signals being projected in an image mode.

Resetting the Image Settings

[Reset]

- | | |
|----------------------------------|-------------------------------------|
| <input type="radio"/> HDMI | <input type="radio"/> COMPONENT |
| <input type="radio"/> DIGITAL PC | <input type="radio"/> VIDEO/S-VIDEO |
| <input type="radio"/> ANALOG PC | <input type="radio"/> USB |



You can reset the current image settings to the default settings.

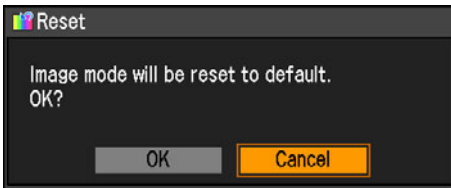

OK	Resets the image settings.
Cancel	Cancels resetting of the image settings.

Press the **OK** button to accept your setting and then press the **MENU** button.

- Only the setting of the combined input signals being projected and an image mode is reset.

Setting Various Function

Setting Auto Setup Function

[Auto setup]

- | | |
|----------------------------------|-------------------------------------|
| <input type="radio"/> HDMI | <input type="radio"/> COMPONENT |
| <input type="radio"/> DIGITAL PC | <input type="radio"/> VIDEO/S-VIDEO |
| <input type="radio"/> ANALOG PC | <input type="radio"/> USB |



You can select an items you want to enable in the auto setup function.

SX80



Select [On] for the items if you want to enable in auto setup function.

Auto focus*	Enables the auto focusing.
Auto keystone	Enables the auto keystone correction.
Auto input	Enables the auto input selection.
Auto screen color*	Adjusts color quality of images corresponding to the color of the projection screen.

Press the **OK** button to accept your setting and then press the **MENU** button.

- The factory default settings are as follows:
 [Auto focus*]: [On]
 [Auto keystone]: [On]
 [Auto input]: [On]
 [Auto screen color*]: [Off]
- You cannot change any items in [Auto setup] if [16:9 D. Image shift] is selected for [Screen aspect]. In addition, you cannot perform the auto setup function. For the details of the [Auto setup], refer to the page 50.

* is only applicable to SX80

Selecting the Power Management Mode

[Power management mode]

- | | |
|----------------------------------|-------------------------------------|
| <input type="radio"/> HDMI | <input type="radio"/> COMPONENT |
| <input type="radio"/> DIGITAL PC | <input type="radio"/> VIDEO/S-VIDEO |
| <input type="radio"/> ANALOG PC | <input type="radio"/> USB |

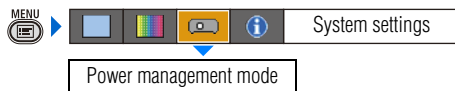

You can turn off the lamp or projector automatically for saving power.

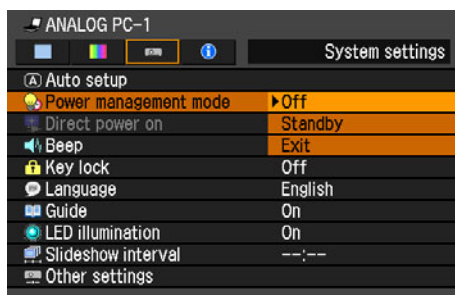

Off	Disables the power management mode.
Standby	If no input signal is received for 30 seconds, the projector enters the standby mode, turning off the lamp five minutes after start of countdown. If it receives the input signal or is operated during such period of 30 seconds, it resumes projection.
Exit	If no input signal is received for 30 seconds, it displays the count down and turns off the projector after 5 minutes.

Press the **OK** button to accept your setting and then press the **MENU** button.

- [Off] is the factory default.
- The POWER indicator flashes red and green when the projector is in the [Standby] power management mode.
- You cannot enable the [Direct power on] function (see the next item), if you select [Off].

Skip the POWER Button Operation

[Direct power on]

- | | |
|----------------------------------|-------------------------------------|
| <input type="radio"/> HDMI | <input type="radio"/> COMPONENT |
| <input type="radio"/> DIGITAL PC | <input type="radio"/> VIDEO/S-VIDEO |
| <input type="radio"/> ANALOG PC | <input type="radio"/> USB |

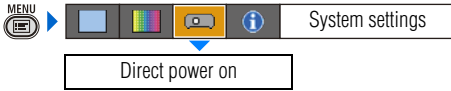

You can turn on the projector only by connecting the power cable without pressing the **POWER** button.

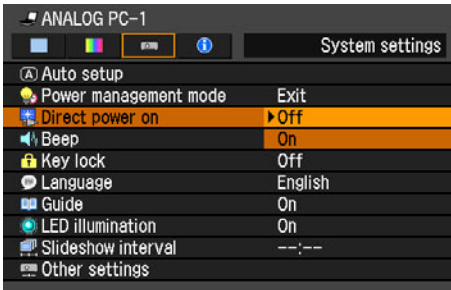

- Off** You need to press the **POWER** button to turn on the projector.
- On** You can turn on the projector only by connecting the power cable.

Press the **OK** button to accept your setting and then press the **MENU** button.

- [Off] is the factory default.



- Before setting the direct power-on to [On], be sure to set the [Power management mode], described on the preceding page, to [Standby] or [Exit].
- Wait at least 5 minutes when you power on the projector again after disconnecting it. It may shorten the lamp life if you turn on the projector immediately after turning it off.

Enabling/Disabling the Beep

[Beep]

- | | |
|----------------------------------|-------------------------------------|
| <input type="radio"/> HDMI | <input type="radio"/> COMPONENT |
| <input type="radio"/> DIGITAL PC | <input type="radio"/> VIDEO/S-VIDEO |
| <input type="radio"/> ANALOG PC | <input type="radio"/> USB |



You can select whether a beep sounds or not when you operate the projector.

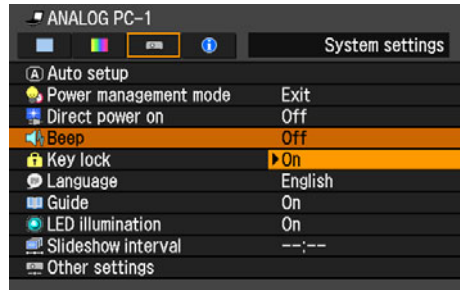

- Off** Disables the beep.
- On** Enables the beep.

Press the **OK** button to accept your setting and then press the **MENU** button.

- [On] is the factory default.
- It does not beep if you mute the projector sound with the **MUTE** button on the remote control.

Prohibiting the Projector Operation

[Key lock]

- | | |
|----------------------------------|-------------------------------------|
| <input type="radio"/> HDMI | <input type="radio"/> COMPONENT |
| <input type="radio"/> DIGITAL PC | <input type="radio"/> VIDEO/S-VIDEO |
| <input type="radio"/> ANALOG PC | <input type="radio"/> USB |

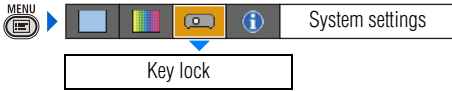

You can prohibit the operation of the projector from either the top control or remote control.

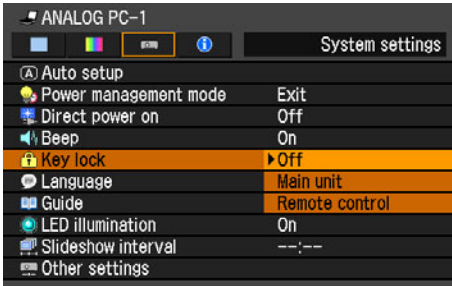

Off	Disables the key lock.
Main unit	Prohibit the operation from the main unit. Use the remote control.
Remote control	Prohibit the operation from the remote control. Use the main unit.

Press the **OK** button to accept your setting and then press the **MENU** button.

- [Off] is the factory default.

! The key lock function becomes effective from the moment the **OK** button is pressed after selecting [Main unit] or [Remote control]. Be sure to press the **OK** button on the top control or remote control which is not locked.

To Unlock Key Lock Function

Turn off the projector and unplug the power plug. Hold down the **OK** button on the top control and connect the power plug. Make sure to keep holding down the **OK** button until a beep sounds. The key lock is unlocked.

Selecting a Display Language

[Language]

- | | |
|----------------------------------|-------------------------------------|
| <input type="radio"/> HDMI | <input type="radio"/> COMPONENT |
| <input type="radio"/> DIGITAL PC | <input type="radio"/> VIDEO/S-VIDEO |
| <input type="radio"/> ANALOG PC | <input type="radio"/> USB |

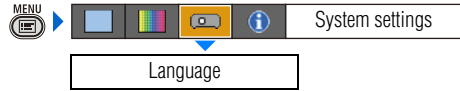

You can select the language in which the menu is displayed.



Use [\wedge] / [\vee] / [$<$] / [$>$] to select the language to be used in the menu, then press the **OK** button.

English	English
Germany	Deutsch
French	Français
Italian	Italiano
Spanish	Español
Portuguese	Português
Swedish	Svenska
Russian	Русский
Dutch	Nederlands
Finnish	Suomi
Norwegian	Norsk
Turkish	Türkçe
Polish	Polski
Hungarian	Magyar
Czech	Čeština
Danish	Dansk
Arabic	إنجليزي
Chinese (Simplified)	中文简体
Chinese (Traditional)	中文繁體
Korean	한국어
Japanese	日本語

When the setting is completed, press the **MENU** button.

Showing/hiding the Guide Screen

[Guide]

- | | |
|----------------------------------|-------------------------------------|
| <input type="radio"/> HDMI | <input type="radio"/> COMPONENT |
| <input type="radio"/> DIGITAL PC | <input type="radio"/> VIDEO/S-VIDEO |
| <input type="radio"/> ANALOG PC | <input type="radio"/> USB |

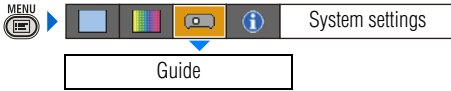

You can select whether to show or hide the guide screen which explains operations.

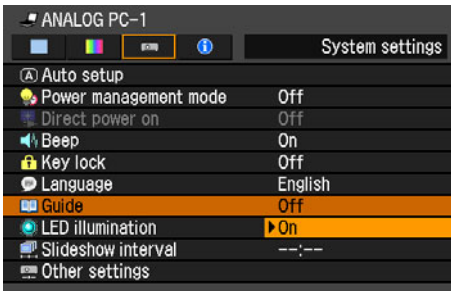

Off Hides the guide screen.

On Shows the guide screen.

Press the **OK** button to accept your setting and then press the **MENU** button.

- [On] is the factory default.
- The guide screen is shown when:
 - Power is turned off by pressing the **POWER** button (P66).
 - No input signal can be detected (P49).
 - An invalid button is pressed in the [BLANK], [FREEZE], or [D.ZOOM] mode (P68, 70).

Turning on/off LED Illumination

[LED illumination]

- | | |
|----------------------------------|-------------------------------------|
| <input type="radio"/> HDMI | <input type="radio"/> COMPONENT |
| <input type="radio"/> DIGITAL PC | <input type="radio"/> VIDEO/S-VIDEO |
| <input type="radio"/> ANALOG PC | <input type="radio"/> USB |

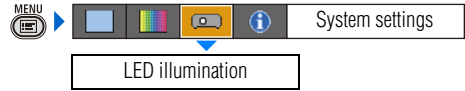

You can select whether to turn on or off LED illumination (P26).

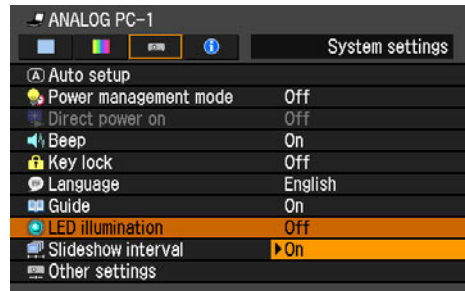

Off Disables the LED illumination.

On Enables the LED illumination.

Press the **OK** button to accept your setting and then press the **MENU** button.

- [On] is the factory default.
- LED illumination is unrelated to turning on/off of the **POWER** or **WARNING** lamp.

Setting for Slideshow (SX80)

[Slideshow interval]

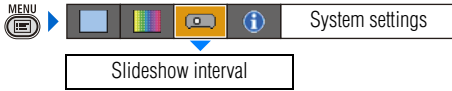

You can project the images stored in a PictBridge-compatible device (P108) or a USB flash memory (P112) in the slideshow.

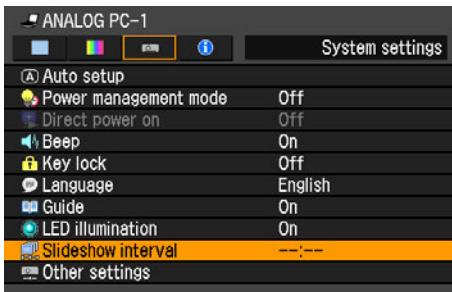

Use [$<$] / [$>$] to set the interval (minutes : seconds) of projection (60 minutes = maximum).

Set [-- : --] if no slideshow is performed. When the setting is completed, press the **MENU** button.

- [-- : --] is the factory default.
- The maximum length of slideshow time is 60 minutes (60:00).
- Use the USB file browser for the projection from the USB flash memory. For more details, refer to the page 114.

Setting up the Remote Control Channel

[Other settings] - [Remote control]

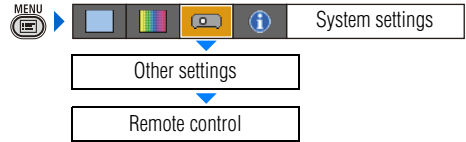

You can set different channels to different remote controls, if you use two projectors at the same time.

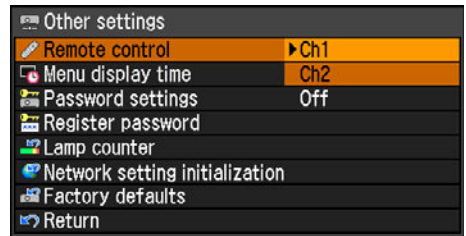

Ch1 Select the channel of the remote control used for this projector, and press the **OK** button.

Ch2 Press the **OK** button.

Press the **OK** button to accept your setting and then press the **MENU** button.

- The factory defaults is [Ch1] for both projector and remote control.
- After changing the channel on the menu, be sure to change the channel of the remote control, too.

Selecting a Channel on the Remote Control

You can change the channel on the remote control as follows:

Ch1 Press the **OK** button and [\wedge] for 3 seconds at the same time.

Ch2 Press the **OK** button and [$>$] for 3 seconds at the same time.

Extending the Menu Display Time

[Other settings] - [Menu display time]

- HDMI
- DIGITAL PC
- ANALOG PC
- COMPONENT
- VIDEO/S-VIDEO
- USB

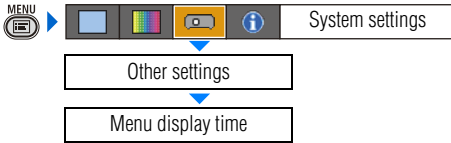

You can extend the menu display time, which is 30 seconds usually, to 3 minutes.

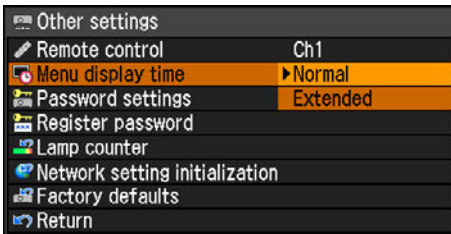

Normal The menu is displayed for 30 seconds.

Extended The menu is displayed for 3 minutes.

Press the **OK** button to accept your setting and then press the **MENU** button.

- [Normal] is the factory default.
- You cannot extend the display time for the window indicating the completion of Auto setup (P51), the guide window (P100), the lamp replacement window (preparation) (P133), or the lamp replacement window (warning) (P133).
- You cannot use the button holding operation except when you adjust the image size (P56) or focus (P57).

Setting a Password

[Other settings] - [Password settings]

- HDMI
- DIGITAL PC
- ANALOG PC
- COMPONENT
- VIDEO/S-VIDEO
- USB

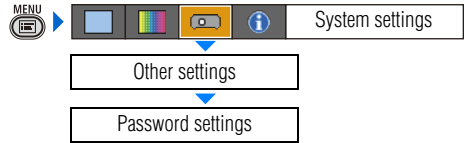

Disables the projector unless the correct password is entered.

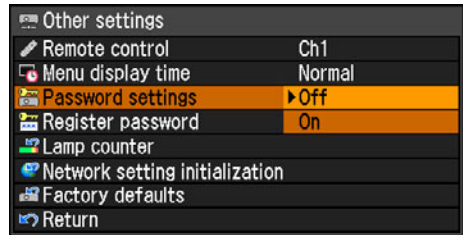

Off The projector can be used even if no password is entered.

On The projector cannot be used unless you enter your password.

Press the **OK** button to accept your setting and then press the **MENU** button.

- [Off] is the factory default.
- You cannot set [On] unless you have completed [Register password].

Once you set a password, the password entry screen appears at power-on. Enter a 4-digit password with [Δ] / [∇] / [\leftarrow] / [\rightarrow]. If the password is valid, the projection starts. If you enter a wrong passwords three times, the power will be turned off.

- The power is also turned off if no password is inputted for 3 minutes.

To Cancel the Password

Turn off the projector and unplug the power plug. Hold down the **MENU** button on the top control and connect the power plug. Make sure to keep holding down the **MENU** button until a beep sounds. The password is cancelled (the registered password is also reset).

Registering a Password

[Other settings] - [Register password]

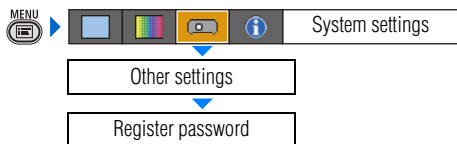

You can register a password for starting projection.

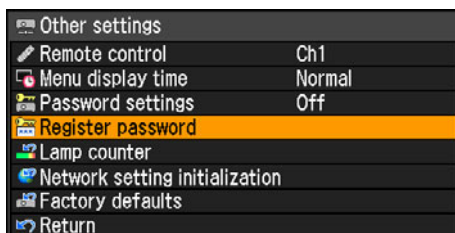

Press the **OK** button after selecting [Register password], and the following screen for registering a password appears:

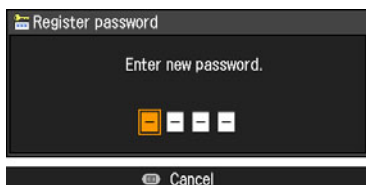

Enter a 4-digit password using [\wedge] / [\lt] / [\vee] / [\gt] (e.g., $\wedge\wedge\wedge\wedge$, $\lt\lt\lt\lt$, $\wedge\vee\lt\gt$).

The 4-digit password is entered from the left to right digits, the password is automatically registered.

- Press the **MENU** button to abort the registration.

Resetting the Lamp Counter

[Other settings] - [Lamp counter]

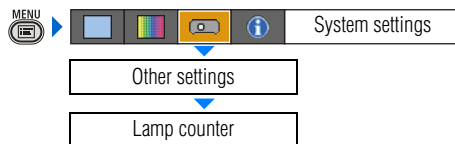
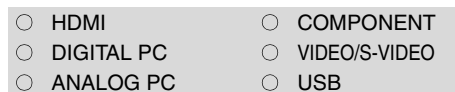

You can reset the lamp counter that indicates the timing to replace the projector when you replace it.

! Do not reset the lamp counter except when you have replaced the lamp. Otherwise, the lamp counter cannot indicate the correct timing for replacing the lamp. For the details of the lamp replacement, refer to the page [134](#).

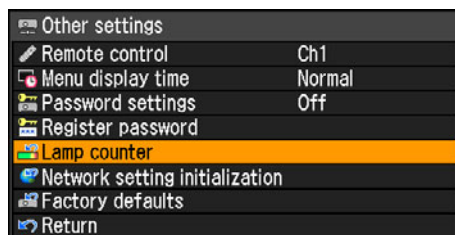

Press the **OK** button after selecting [Lamp counter], and the lamp counter is displayed.

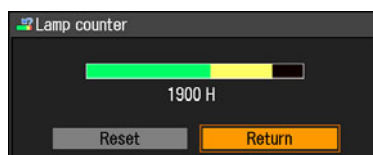

Select the [Reset] and press the **OK** button.

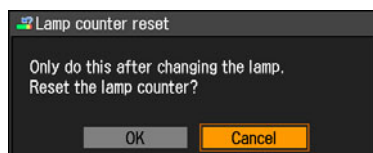

Select [OK] on the screen for confirmation, press the **OK** button, and the lamp counter is reset.

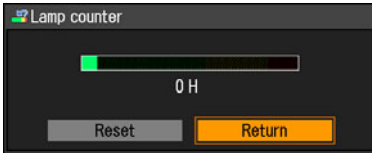

Press the **MENU** button.

■ About the Display of the Lamp Counter

The lamp counter displays the hours of use of the lamp in the following way:

Less than 1,800 hours

Displayed in green bar.

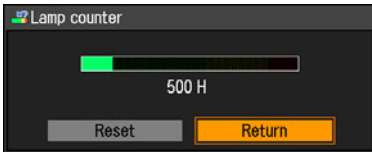

1,800 – less than 2,000 hours

Displayed in green and yellow bar.

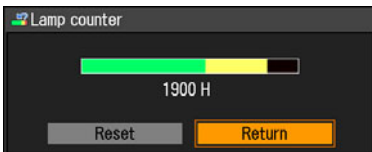

For 1,800 – less than 2,000 hours, a message "Obtain a new lamp." appears when power is turned on.



Over 2,000 hours

Displayed in green, yellow and red bar.

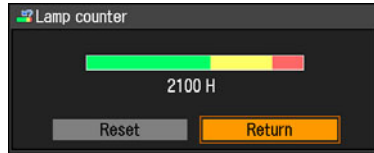

A message "Replace with the new lamp." appears when power is turned on.

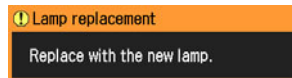

Initializing network settings (SX80)

[Other settings] - [Network setting initialization]

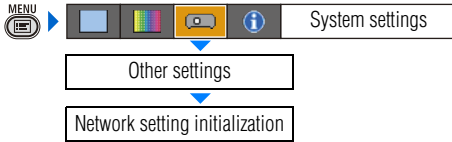

You can Initialize the network settings.

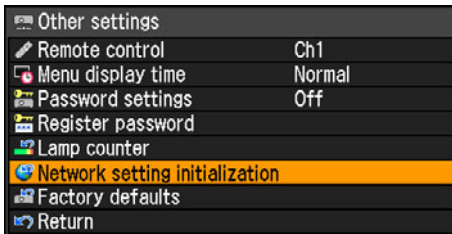

Press the **OK** button after selecting [Network setting initialization], and the following screen for confirmation appears:

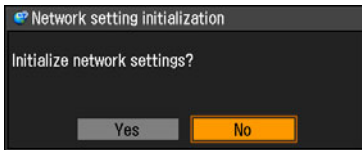

Yes	The network settings is initialized.
No	Initialization is aborted.

Press the **OK** button to accept your setting and then press the **MENU** button.

- Initialized are "IP address" and other items set in "Connecting the Projector to Network (SX80)" (P119).
- You can do this initialization also from a Web browser. (P123)

Resetting to the Default Setting

[Other settings] - [Factory defaults]

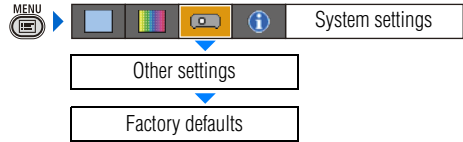

You can reset the menu item settings and restore the system settings to the factory defaults.

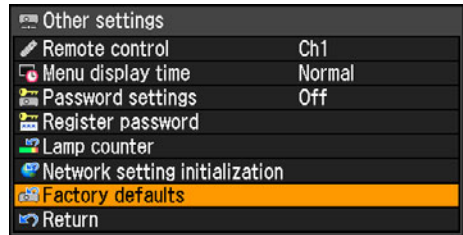

Press the **OK** button after selecting [Factory defaults], and the following screen for confirmation appears:

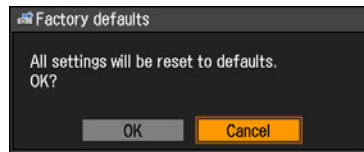

OK	Settings are reset to default.
Cancel	Settings are not reset to default.

Press the **OK** button to accept your setting and then press the **MENU** button.

- This function cannot reset the value of [Lamp counter], [Language], [Remote control], [Input signal] and [Network setting] to default.
- For factory defaults settings, refer to the page 152.

Checking the Information of the Projector

[Information]

- HDMI
- DIGITAL PC
- ANALOG PC
- COMPONENT
- VIDEO/S-VIDEO
- USB



You can confirm the information about the signal types of the images projected and other projector-specific information.

SX80

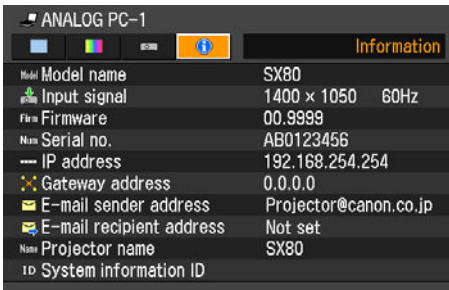

SX800

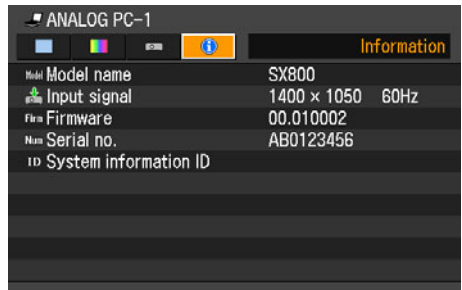

Information shown

Item	Meaning
Model name	Model name of this projector
Input signal	Details of the input signal currently selected "Type of signal", "resolution of signal", "frequency" and other information is shown.
Firmware	Current firmware version
Serial no.	Serial number unique to this projector
IP address (SX80)	Details of the network settings (P120)
Gateway address (SX80)	[Not set] is shown for an item having no settings.
E-mail sender address (SX80)	
E-mail recipient address (SX80)	
Projector name (SX80)	ID of this projector on the network
System information ID	This is an item of system information. Normally this is not displayed.

Projecting an Image from a Digital Camera or an USB Flash Memory (SX80)

Table of Contents

Safety Instructions

Before Use

Projecting an Image

Useful Functions Available During a Presentation

Setting Up Functions from Menus

Projecting an Image from a Digital Camera or an USB Flash Memory (SX80)

Connecting the Projector to Network (SX80)

Appendix

Index

Projecting an Image from a Digital Camera (SX80)

SX80 supports PictBridge. You can directly project an image by connecting the projector with a PictBridge-compatible digital camera, digital video camera or camera-equipped mobile phone (hereinafter called "PictBridge-compatible device").

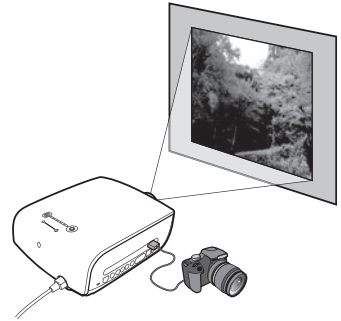

Connectable Cameras

PictBridge is an industry standard enabling the direct printing of images from a digital camera, digital video camera, camera-equipped mobile phone, etc. using a cable without the computer.

With this projector, you can directly project an image by connecting a PictBridge-compatible device and by using the same operation as that of printing.



Cameras bearing this mark supports PictBridge.

For the up-to-date information regarding PictBridge, visit Cannon's website (http://pbdb.jp.canon.com/pictbridge_e/) or PictBridge's website (http://www.cipa.jp/pictbridge/index_e.html).

Connecting a Digital Camera

- 1 Turn the projector power on.
- 2 Switch the input signal to [USB].
Press the **INPUT** button, select [USB] with [\wedge] / [\vee] buttons, and press the **OK** button.

Remote control

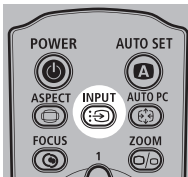

Top control

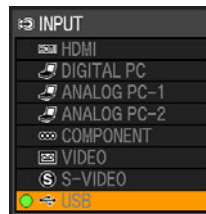
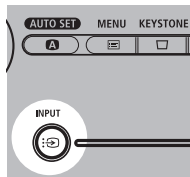

If you switch to [USB] when a PictBridge-compatible device is not connected or not powered on, the screen as shown in the right appears.

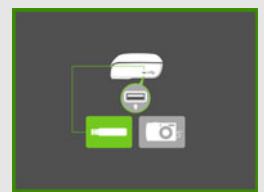

3 Connect a PictBridge-compatible device with the projector using a USB cable.

The terminal form of the device varies depending on the model. Refer to the User's Manual for the relevant equipment.

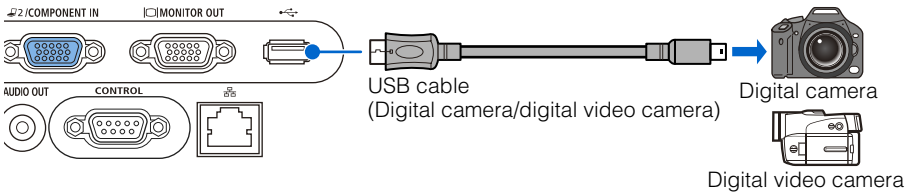

4 Turn on the power of the PictBridge-compatible device.

When the communication is ready between the projector and the PictBridge-compatible device, the following mark appears.

With Canon digital camera



With non-Canon digital camera

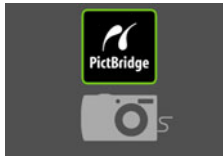

If the projector does not recognize the device or communication is disabled, the screen as shown in the right appears.

If a PictBridge-compatible device is connected, pull out the USB cable and connect it again.



If the screen as shown in the right (USB file browser) appears, the device supports the USB mass storage class (serves as an external hard drive to Windows computers), and you can project an image according to the system. For more details, refer to the page [112](#).

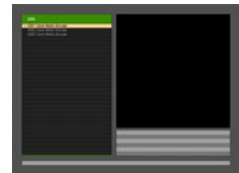

- Use a fully-charged battery for PictBridge-compatible device.
- Do not disconnect the cable until projection is ended unless the PictBridge-compatible device allows to do so. For the removal procedure of the cable, refer to the User's Manual for the PictBridge-compatible device.

5 Operate the PictBridge-compatible device

Operate the PictBridge-compatible device to start "printing".

The image is transferred to the projector, and projected on the screen.

- You can select from [Single print (project single image)], [Continuous print (project all images continuously)], and [DPOF print (project specified image)].
With [DPOF print], up to 999 images can be specified for projection.
- To view the next image with [Continuous print] and [DPOF print] selected, press the OK button.

Operating the Projected Image

When images are projected, you can perform the following operations.

■ Switching to the Next Image

If you have specified multiple images for printing with the digital camera, you can switch to the next image by pressing the **OK** button.

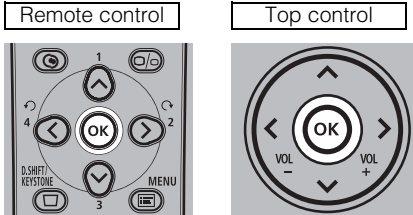

- You cannot switch to the previous image with the projector operation. To switch to the previous image, you must retry the print command with the digital camera.
- Even if a slideshow is running, you can switch to the next image by pressing the **OK** button.

■ Rotating an Image

You can rotate the image by 90 degrees to the left or to the right by pressing [**<**] / [**>**].

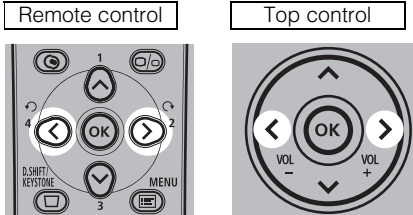

- Even if a slideshow is running, you can rotate the image by pressing [**<**] / [**>**].
- If the image contains rotational information, the image is rotated to an appropriate direction automatically.

Running a Slideshow

You can run a slideshow that projects multiple images stored in the digital camera at certain intervals.

■ Setting a Slideshow Interval

By setting projection intervals in [Slideshow interval] from the menu, you can run a slideshow of the images (with PictBridge or from a USB flash memory) connected via USB. Set the slideshow interval by following the steps below.

- 1 Press the MENU button to display the menu.

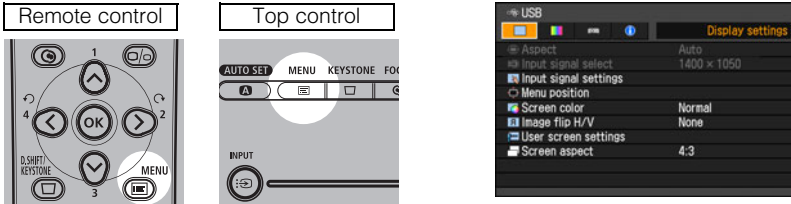

- 2 Select [System settings] tab with [←] / [→], and select [Slideshow interval] with [↑] / [↓].

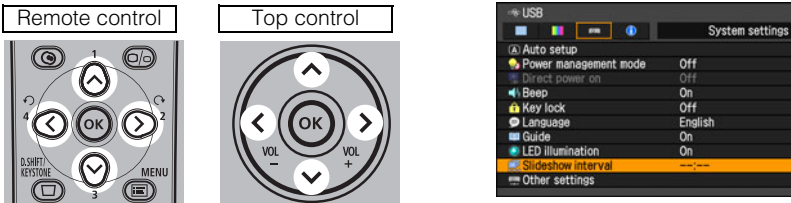

- 3 Set the interval (minute:second) other than "--:--" with [←] / [→]. To stop the slideshow, set as "--:--".

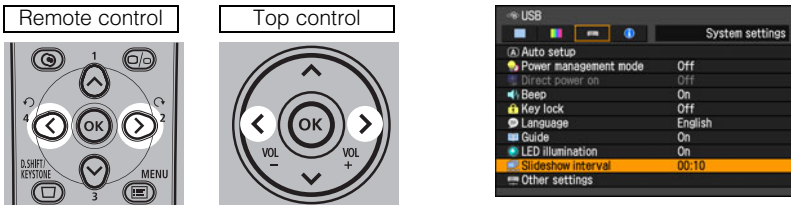

- 4 Press the MENU button to exit the menu. It may take a certain time depending on the screen size.

■ Finishing projection

To finish projecting images using PictBridge, turn off the power to the PictBridge enabled equipment.

Then, remove the USB cable from the equipment.

Projecting Data on USB Flash Memory (SX80)

You can connect a USB flash memory to the projector for direct projection of the images (saved in JPEG format) saved in the USB flash memory.

- Images saved only in JPEG format are available for projection.

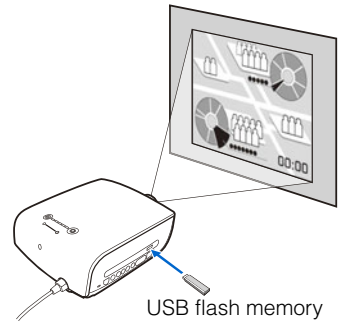

Connectable USB Devices

With this projector, you can connect the USB devices (general USB flash memories or USB-connected hard disks) that support the mass storage class (serves as an external hard drive to Windows computers).

Also, you can connect various memory cards via USB memory card readers.

You can also connect a digital camera or digital video camera that supports a USB mass storage class mode for image projection.

Connecting a USB Flash Memory

- 1** Turn the projector power on.
- 2** Switch the input signal to [USB].
Press the **INPUT** button, select [USB] with [\wedge] / [\vee] buttons, and press the **OK** button.

Remote control

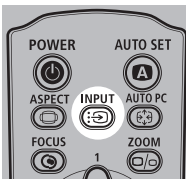

Top control

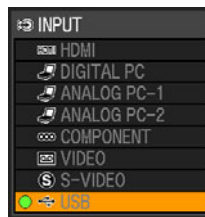
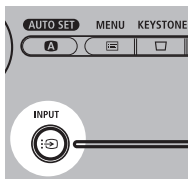

If you switch to [USB] when a USB flash memory is not connected or the hard disk is not powered on, the screen as shown in the right appears.

If the projector recognizes a USB flash memory, The "USB file browser" appears.

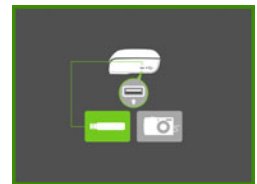

3 Connect a USB flash memory.

Connect a USB flash memory to the USB terminal.

Use a USB cable to connect a digital camera or USB memory card reader.

Be sure to use the USB cable supplied with the equipment connected to the projector.

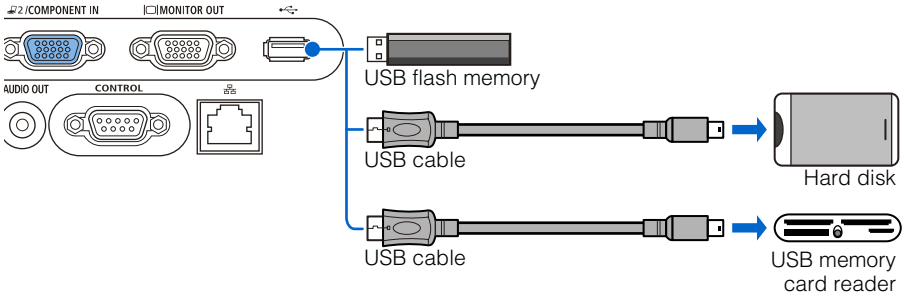

If the projector recognizes a USB flash memory, The "USB file browser" appears.

- Only the drive which has been set in advance is displayed.
- If multiple memory devices are attached to a multiple-card reader, the folder up one level in the hierarchy is displayed.

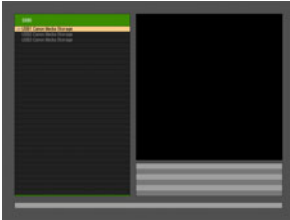

If connection to the USB flash memory fails, the screen as shown in the right appears.

Disconnect the USB flash memory, and connect it again.

If the projector does not recognize the device, the screen as shown in the right appears.



- If a USB hub is connected, the screen as shown in the right appears.
- You cannot connect a USB hub to this projector.
- When connecting a device which consumes large amount of power such as USB hard disk, use a commercial power supply.
- If the power supplied from the USB terminal is insufficient, malfunction of the USB flash memory may result or the projector unable to recognize the device.



Description of USB File Browser

If a USB flash memory is connected to the projector, the USB file browser appears. In the USB file browser, you can select the image file to be projected by operating the file list in the USB memory device.

List title

Drive name currently selected
Representation varies depending on the manufacturer and/or model.



Page number of the file list currently displayed
(Current page number/total number of pages)
You can page up and down with [

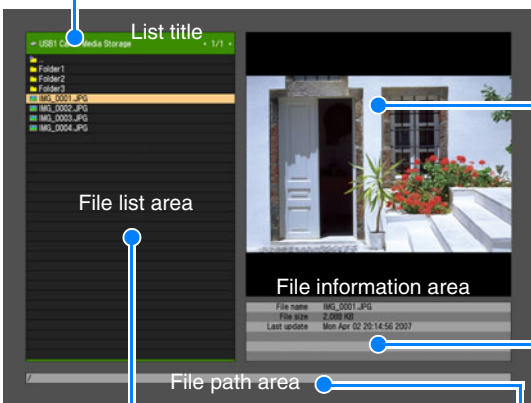

List title

File list area

Preview area

File information area

File path area

Preview area

Image selected in the file list appears with reduced size. If a folder is currently selected, the folder icon appears.



File information area

Information of the image selected in the file list appears here.

- File name
- File size
- Date time original (date and time of when the image was taken) ("Last update" may appear instead.)
- Image size (resolution)
- Model
- Shooting information (shutter speed, diaphragm, ISO sensitivity)

File list area

File list within the folder appears in the order of file name. Select an image file or folder with [^] / [v].

-  Folder
-  Available image file

File path name

Path name of the image selected in the file list appears here.

Selecting an Image for Projection

This section describes the steps for selecting an image in the USB file browser and projecting on the screen.

■ Selecting a Drive

If a USB flash memory is connected, skip this step.

If a USB memory card reader having multiple memory slots is connected, the drive (memory slot) list is displayed in the file list.

Select the drive in which the memory card is inserted with [\wedge] / [\vee], and press the **OK** button.

Remote control



Top control

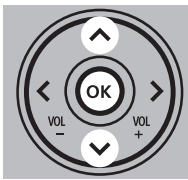

- Active drives are displayed in white text, while inactive drives are grayed out.
- Icons indicate the memory card status of each drive. (They differ depending on the connected equipment.)



Example 1) Memory card is inserted and recognized properly.



Example 2) Memory card is inserted but cannot be recognized.

The file system is destroyed or the projector cannot recognize its format.

■ Selecting a Folder

If the image file is located in a folder, select the folder with [\wedge] / [\vee], and press the **OK** button.

Remote control



Top control

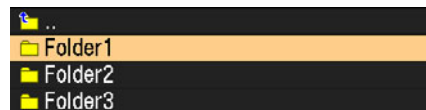
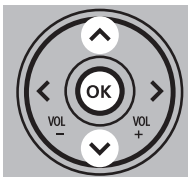

- To return to upper hierarchy, select   .. and press the **OK** button.

■ Selecting an Image File for Projection

1 Select an image file with [\wedge] / [\vee].

Remote control



Top control

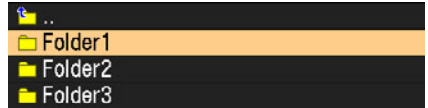
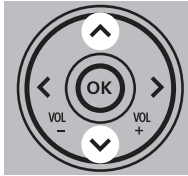

The selected image appears in the preview area with reduced size.

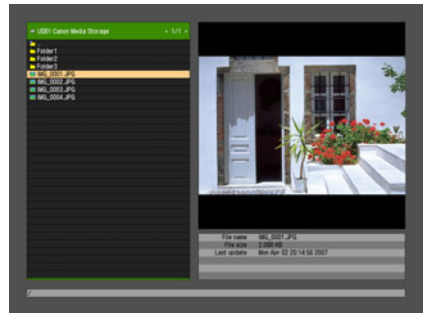

- To return to upper hierarchy, select  and press the OK button.

2 Press the OK button to project the image in full screen.

Remote control

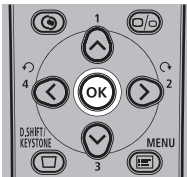

Top control

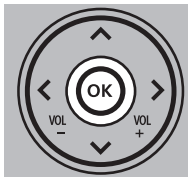

- To return to the USB file browser, press the OK button.

Operating the Projected Image

When images are projected, you can perform the following operations.

■ Switching to the Previous/Next Image

If multiple image files are saved in a folder, you can switch to the previous/next image by pressing [Δ] / [∇].

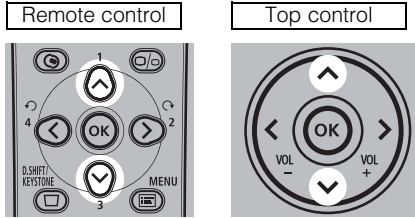

- Even if a slideshow is running, you can switch to the previous/next image by pressing [Δ] / [∇].

■ Rotating an Image

You can rotate the image by 90 degrees to the left or to the right by pressing [\leftarrow] / [\rightarrow].

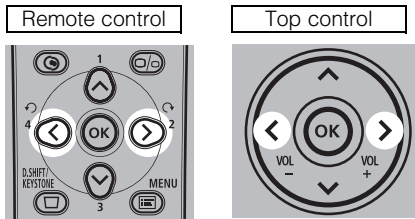

- Even if a slideshow is running, you can rotate the image by pressing [\leftarrow] / [\rightarrow].
- If the image contains rotational information, the image is rotated to an appropriate direction automatically.

■ Returning to the USB File Browser

To return to the USB file browser, press the OK button.

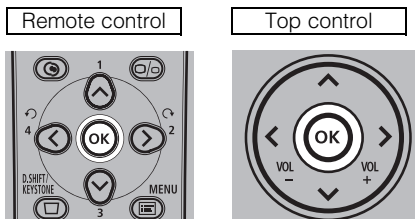

Running a Slideshow of Data saved in a USB Flash Memory

You can run a slideshow that projects multiple images stored in a USB flash memory at certain intervals.

■ Creating an Image File Folder

In the slideshow, image files in a folder are displayed in the alphabetical order of file name. Therefore, create a folder in the USB flash memory and save the image files to be projected in the slideshow in advance.

To start a slideshow, select and project the first image file in a folder in the full-screen display mode using the USB file browser.

If the "slideshow interval" described below has been set, the image files in a folder are automatically projected in sequence.

■ Setting a Slideshow Interval

To run a slideshow, set the time interval in [Slideshow interval] from the menu in advance. For the details of the setting step, refer to "Running a Slideshow" on page [111](#).

Connecting the Projector to Network (SX80)

Table of Contents

Safety Instructions

Before Use

Projecting an Image

Useful Functions Available During a Presentation

Setting Up Functions from Menus

Projecting an Image from a Digital Camera or an
USB Flash Memory (SX80)

Connecting the Projector to Network (SX80)

Appendix

Index

Setting an IP Address (SX80)

By connecting SX80 to the network, you can receive an error notification message from the projector or control the projector from your computer. (P123)

To connect via the network, an IP address must be assigned to the projector. Set an IP address by following the steps below. (The examples shown are Windows XP screenshot images.)

■Setting IP Address of the Computer

- 1 Connect the projector and a computer directly via a cross type LAN cable.

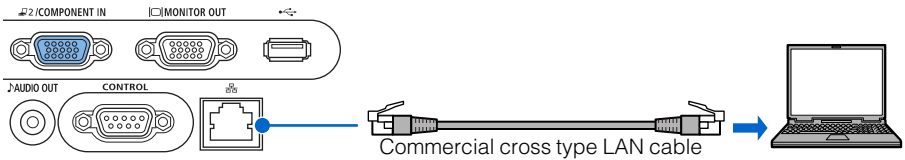

- 2 Turn on the power of the projector and computer.
- 3 Open [Control Panel] from the [Start] menu, then select [Network and Internet Connections] - [Network Connections].
- 4 Right-click [Local Area Connection], and open [Properties].
- 5 Select [Internet Protocol (TCP/IP)] and click the [Properties] button. Take notes of the original network settings (IP address, subnet mask, DHCP settings, etc).
- 6 Select [Use the following IP address] and set as follows:
[IP address]: 192.168.254.1
[Subnet mask]: 255.255.255.0

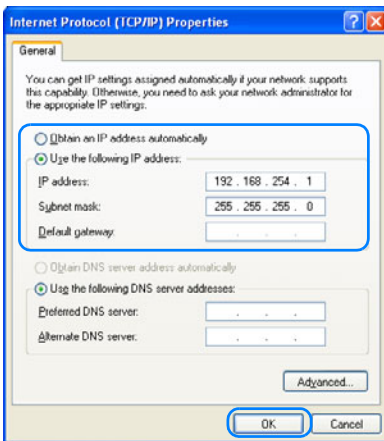

- 7 When you have specified the settings, click the [OK] button and then click the [OK] button on the [Local Area Connection Properties] window to close it.

■ Resetting the IP Address Setting of the Computer

- 1 Turn off the projector, and remove the LAN cable.
- 2 Follow the steps 3 to 6 to restore the computer's IP address and subnet mask that you have written down to the original values.

■ Setting the Error Notification Message

- 1 Launch a web browser, enter "http://192.168.254.254" in the address bar, and press the Enter key.
The login dialog box appears.
The supported web browsers is Microsoft Internet Explorer 6 or later.

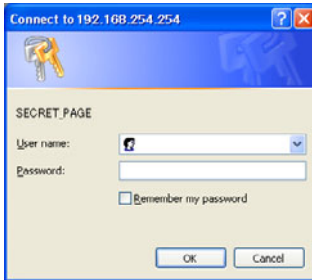

- 2 In the password setting screen, enter "root" for [User name] and "system" for [Password], and click the [OK] button.

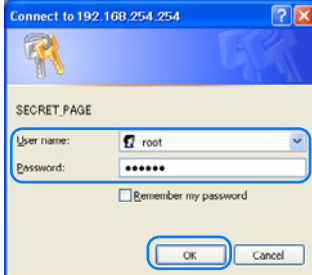

The projector's network setting screen appears on the web browser.

- 3 Click the [Settings] button on the network setting screen.



The menu screen appears.

- 4** Click [TCP/IP], enter appropriate values in the following field, and click the [OK] button.
 [IP address]: IP address of projector
 [Subnet mask]: Subnet mask of projector
 [Default gateway]: Default gateway of network



- 5** Click [Mail], enter appropriate values in the following field for the error report, and click the [OK] button.

- [To:]: E-mail address to which error notification message is sent. (Within 63 alphanumeric characters)
- [Cc:]: Second E-mail address to which error notification message is sent (Within 63 alphanumeric characters, can be omitted).
- [From:]: Sender of E-mail (projector)
- [SMTP server IP address]: IP address of available SMTP server
- [SNTP server IP address]: IP address of available SNTP server (can be omitted)
- [Time zone]: Time zone of installation site
- [Mail resend interval]: E-mail resend interval if the transmission has failed
 Setting range: 0 – 59 seconds (factory default: 10 seconds)
- [Mail resend times]: Number of resend times if the E-mail transmission has failed
 Setting range: 0 – 255 times (factory default: 3 times)
- [Error report]: ON/OFF of error message sending function. Select [ON].
 [OFF] is the factory default.



- 6** Click [Apply], and then click the [OK] button when the "Save and apply settings. OK?" message appears.
This completes the IP address setting of the projector.

■ If You Want to Reset the Network Setting

- 1** Access to the projector from a web browser by referring to the step 1 on "Setting the Error Notification Message (P121)."
- 2** Click [Initialize] in the network setting screen (P122).
- 3** Click the [OK] button when "Initialize network settings?" message appears.
To restore the settings with the projector operation, execute [Network setting initialization] from the menu.

■ Error Notification Message

If errors occur in the projector, the following messages are sent.

Error list

Errors related to temperature	Error name	Temperature abnormality
	Text	The temperature inside the projector is too high for some reason or the outside air temperature is higher than the specified one. If the problem is inside the projector, check whether the projector is installed and operated normally, turn off the projector to cool its inside, and retry projection. If the same warning occurs again, the projector may be defective. Contact your dealer.
Errors related to the lamp	Error name	Faulty lamp
	Text	The lamp has burnt out. Replace the lamp with a new one. If the same warning occurs again, the lamp drive circuit may be defective. Contact your dealer.
Errors related to the lamp cover	Error name	Faulty lamp cover
	Text	The lamp cover is open. Check whether the lamp cover is installed properly. If it is installed properly, the lamp cover detection switch may be defective. Contact your dealer.
Errors related to the cooling fan	Error name	Faulty cooling fan
	Text	The cooling fan or another component may be defective. Contact your dealer.
Errors related to the power supply	Error name	Faulty power supply
	Text	The voltage of part of the power supply is abnormally high or any other problem has occurred in the power supply. Contact your dealer.
Other types of errors	Error name	Unknown Error
	Text	Codes in hexadecimal numbers*

* Contact your Canon dealer.

Appendix

Table of Contents

Safety Instructions

Before Use

Projecting an Image

Useful Functions Available During a Presentation

Setting Up Functions from Menus

Projecting an Image from a Digital Camera or an
USB Flash Memory (SX80)

Connecting the Projector to Network (SX80)

Appendix

Index

Troubleshooting

WARNING Lamp Flash Patterns

The WARNING lamp on the Control Panel flashes in red when there is a trouble in the projector.

- Turn off the projector, wait until the cooling fan stops, and remove the power plug from the AC outlet before dealing with the trouble.

Flash Pattern	Meaning	Countermeasure
One flash	Temperature, abnormality	The temperature inside the projector is too high for some reason or the outside air temperature is higher than the specified one. If the problem is inside the projector, check whether the projector is installed and operated normally, turn off the projector to cool its inside, and retry projection. If the air intake or exhaust vent is blocked, remove the obstacle. If the same warning occurs again, the projector may be defective. Contact your dealer.
Two flashes	Faulty lamp	The lamp has burnt out. Replace the lamp with a new one. If the same warning is experienced again, the lamp drive circuit may be defective. Contact your dealer.
Three flashes	Faulty lamp cover	The lamp cover is open. Turn off the projector and unplug it from the power outlet, then install the lamp cover and turn on the projector again. If the lamp cover has been installed properly, the lamp cover detection switch may be defective. Contact your dealer.
Four flashes	Faulty cooling fan	The cooling fan or another component may be defective. Contact your dealer.
Five flashes	Faulty power supply	The abnormal voltage is applied to some parts in the power supply or any other failure may be occurred. Turn off the projector and unplug it from the power outlet, then plug it to the outlet and turn on the projector again. Contact your dealer if the same warning is given.

Symptoms and Solutions

■ You cannot turn on the projector.

Cause	Countermeasure
The power cord is not connected correctly.	Check whether the power cord is connected correctly. (P47) Check that [Key lock] is not enabled. (P99)
The power cord has just been connected.	You cannot turn on the projector until the POWER indicator turns red after connecting the power plug. (P47)
The lamp cover is open.	Unplug the power cord from the power outlet and correctly install the lamp cover and then turn on the projector again.
The safety device has activated because you put the projector in the carrying bag during the cooling fan was rotating.	When the safety device is active, the POWER lamp does not turn on when you connect the power cord. You cannot release the safety device. Contact your dealer.
The safety device is activated because the air intake or the exhaust vent is blocked and the internal temperature of the projector is increased.	When the safety device is active, the POWER lamp does not turn on when you connect the power cord. You cannot release the safety device for safety reason. Remove any obstacle that is blocking the air intake or exhaust vent and contact your dealer.

■ You cannot project an image from the projector.

Cause	Countermeasure
Any connection cable is connected incorrectly.	Check whether the projector is connected to the computer or AV equipment correctly. (P36, P37, P52)
20 seconds have not passed since the projector was turned on.	When the projector is turned on, the Opening window is displayed for approximately 20 seconds. To project an image immediately, press the OK button on the remote control or top control. (P47)
No image is sent from the AV equipment.	Check that an image is played on the connected digital camera, video camcorder, DVD, etc.
The wrong video terminal or signal type is selected.	Check that the correct video terminal and signal type are selected. (P36, P37, P52)
No input signal type has been selected.	Press the INPUT button to select an appropriate input signal type. (P53)
The video signal type is incorrect.	Check whether the selected signal type is correct. (P78, P79, P138)
The BLANK function has been selected.	Press the BLANK button on the remote control. (P68)
No image is sent due to the problem in the computer.	Turn on the projector and computer in this order again.

Cause	Countermeasure
The external monitor output is not set on the notebook computer correctly.	Turn on the external monitor output on the notebook computer. To turn on the external monitor output, press the [LCD] or [VGA] function key or a key with an icon for the external monitor, while holding down the [Fn] key on the keyboard of the notebook computer. (P49) The combination of keys used to perform this operation varies among computer manufacturers. For more detailed information, refer to the User's Manual that came with your computer.
The displayed image is not the same as that displayed on the computer.	Check whether the dual screen (multi-display) mode is selected on the computer. If the dual screen mode has been selected, change it to the simultaneous display mode on the computer. The output setting method varies among computer manufacturers. For more detailed information, refer to the User's Manual that came with your computer.
The lens cap is not removed.	Remove the lens cap.

■ **A digital camera or USB flash memory is not recognized. (SX80)**

Cause	Countermeasure
PictBridge is not supported.	Equipment not supporting PictBridge is not recognized. Refer to the User's Manual for the relevant equipment. (P108)
The mass storage class is not supported.	USB flash memory not supporting the mass storage class is not recognized. Refer to the User's Manual for USB flash memory. (P112)

■ **You cannot hear sound.**

Cause	Countermeasure
The audio cable is not connected correctly.	Check the cable connection of the audio cable. (P36, P37)
The MUTE function is enabled.	Press the MUTE button on the remote control. (P69)
The volume level is adjusted to the minimum.	Press the VOL button on the remote control or the VOL+ button on the top control to adjust the volume level. (P69)
An audio cable with a built-in resistor is used.	Use an audio cable without a built-in resistor.

■ The projected image is blur.

Cause	Countermeasure
The image is out of focus.	Adjust the focus. (P57)
The distance to the screen is too short.	Check whether the distance to the screen is appropriate. If the distance is shorter than approximately 1.2m (3.9'), the projector cannot focus on the screen. (P33, P139)
The projector is not placed straight in front of the screen.	Check whether the projector is placed obliquely to the screen. A slight error in the projection angle can be corrected through the keystone adjustment function. (P58)
The projector has been moved to a place where the temperature varies a lot.	When the projector is moved from a low-temperature place to a high-temperature place, condensation may form on the lens. The condensation will evaporate a while later and the projector will be able to project a normal image.
The lens is stained.	Clean up the lens. (P131)
The tracking is bad.	Adjust the tracking with the AUTO PC or Tracking function. (P55, P80)

■ You cannot project an image appropriately.

Cause	Countermeasure
The projected image is inverted in the vertical or horizontal direction.	The ceiling mounted/rear projection setting is incorrect. Check the [Image flip H/V] setting in the [Display settings] menu. (P85)
Using a VGA cable in which some pins are not connected.	<ul style="list-style-type: none"> • Use a supplied VGA cable (for SX800). • If you use a commercial VGA cable, make sure to use a cable in which all pins are connected.

■ The projector is forced to be turned off.

Cause	Countermeasure
The air intake or exhaust vent is blocked.	Check whether the air intake or exhaust vent is blocked. If the air intake or exhaust vent is blocked, the temperature inside the projector rises and the power is automatically turned off to protect the projector. (The WARNING lamp flashes once.) Wait until the internal temperature gets down, and then turn on the projector without blocking the intake and exhaust vents. (P22, P23, P47)
The air filter is dirty.	Check whether the bottom air filter is clogged with dust. If the air filter is clogged, clean or replace the air filter. (P132)
The lamp has exploded (or it is defective).	Check whether the lamp has exploded. If the lamp has exploded, replace the lamp according to "Lamp Handling Precautions" on page 16. Check the lamp by replacing it with a spare lamp if you have one. (P16, P133, P134)

Cause	Countermeasure
The operating temperature is inappropriate.	Check whether the operating temperature is 5 to 35°C. (P18) If you use the projector at 2300 meters or higher above sea level, contact your dealer.
Other reasons	The projector may be damaged. Contact your dealer.

■ You cannot operate the remote control.

Cause	Countermeasure
Batteries are not installed properly or they have run out.	Check whether batteries are installed correctly. If batteries are installed correctly, replace them with new batteries. (P29)
You are operating the remote control from the outside of the remote control operating range.	Check whether you are operating the remote control within the remote control operating range. (P29)
There is an obstacle between the projector and the remote control.	Remove the obstacle between the infrared remote receiver of the projector and the remote control or point the remote control to an obstacle-free path.
You are operating the remote control under an inappropriate operating environment.	Check whether the infrared remote receiver of the projector is exposed to direct sunlight or strong light of lighting apparatus. (P29)
The channel setting of the remote control does not match with the setting of the projector.	Check whether the channel setting of the remote control has been changed. You can check the [Remote control] setting in the [System settings] menu. (P101)
The key lock function is prohibiting the remote control operation.	Check whether [Key lock] is enabled to disable the remote control operation. In the System settings menu, set [Key lock] to [Off]. (P99)

Cleaning the Projector

Clean the projector frequently to prevent dust from settling on the surface. A dirty lens may ruin the quality of the projected image.



- The main unit is very hot immediately after turning off the projector. Wait until the projector cools down sufficiently (more than 1 hour) before cleaning the projector. Otherwise, you may get burned or injured.
- Before cleaning the projector, be sure to remove the power plug from the AC outlet. Otherwise, electric shock or fire may result.

Wipe the projector's main unit softly with a soft cloth.

If the projector is heavily soiled, soak the cloth in water with a small amount of detergent in it, squeeze the cloth very well, and then wipe the projector with it. After cleaning, wipe the projector with a dry cloth.



- Never use volatile cleaning liquid or benzine, as these may damage the finish of the projector.
- When using a chemical dust cloth, make sure to read the instructions thoroughly.
- When cleaning the projector's lens, use a commonly available air blower or lens cleaning paper. The lens surface is easily damaged, so do not use a hard cloth or tissues.

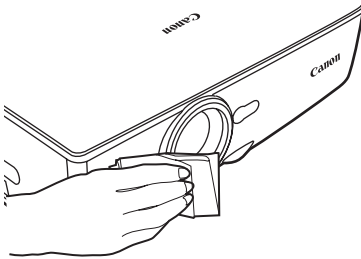

When Not Used for an Extended Period of Time

Be sure to attach the lens cap on the lens and store in the supplied carrying bag.

Cleaning and Replacing the Air Filter

An air filter is installed in the air intake vent on the bottom of the main body to protect the internal lens and mirror from dust. Should the air filter become clogged with dust, the projector may be damaged since it will block the air flow into the projector and raises the internal temperature of the projector. The following screen is displayed when turning on the projector if the air filter needs to be cleaned. Clean the air filter if such is the case.

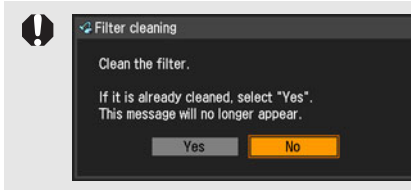

- Only [$<$], [$>$], the OK button, and the **POWER** button are available while this screen is displayed (When you press the **POWER** button, "Push **POWER** button again to turn off power." message appears).
- After this screen has been displayed for 10 seconds and disappeared, all buttons become operable.

■ Cleaning the Air Filter

- Turn the projector upside down, remove the cover by pushing the latch, remove the air filter, and clean it with a vacuum cleaner.
- When cleaning dust off the rear exhaust vent and bottom air intake vent, bring the vacuum cleaner nozzle close to them directly.
- If the above screen is displayed when turning on the projector after cleaning the air filter, select [Yes].

■ Replacing the Air Filter

Make sure to replace the air filter when replacing the lamp. Follow the following procedure when replacing the air filter.

- 1** Turn off the projector, disconnect the power plug from the AC outlet, and let the projector stand for at least 1 hour.
- 2** Remove the filter cover by pushing the position of the arrow.
- 3** Remove the air filter.
- 4** Install a cleaned or new air filter.
- 5** Install the filter cover securely without any space.

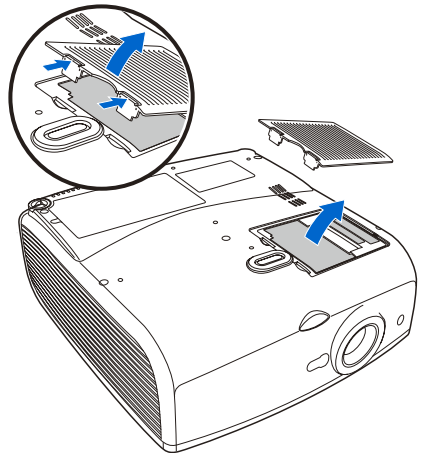

- Handle the air filter carefully. If damaged, the air filter will not work appropriately
- An air filter can be ordered from your dealer.

Replacing the Lamp

When the time of use of the lamp exceeds the certain amount of time, the following message (two types) is displayed for 10 seconds every time the projector is turned on.

1,800 - less than 2,000 hours



Prepare the new lamp when this screen is displayed.

- Only [**<**], [**>**], the **OK** button, and the **POWER** button are available while this screen is displayed.
- When you press the **POWER** button, "Push **POWER** button again to turn off power." message appears.

- After this screen has been displayed for 10 seconds and disappeared, all buttons become operable.
- This message will not be displayed again if you select [**Cancel**] in response to the message "Do you want to display this message again?".

Over 2,000 hours

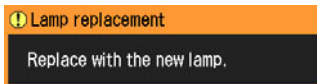

Replace the lamp by referring to the procedure on page [134](#) when this screen is displayed.

- Only the **POWER** button is available while this screen is displayed.
- When you press the **POWER** button, "Push **POWER** button again to turn off the power." message appears.

- After this screen has been displayed for 10 seconds and disappeared, all buttons become operable.
- You can check the time of use of the lamp in [Lamp counter] in the [System settings] menu ([P103](#)).

■ About the Replacing Lamp

This projector uses the following lamp.

Lamp type No.RS-LP05



- Be sure to use the specified lamp.
- A lamp can be ordered from your dealer.
- When replacing the lamp, turn off the projector, wait until the cooling fan stops, disconnect the power plug from the AC outlet, and let the projector stand for at least 1 hour. Otherwise, you may get burned because the main unit is very hot immediately after the projector is turned off.
- Do not touch the inner glass surface when you replace the lamp. Otherwise, the projector's performance may degrade.
- Make sure to handle the lamp carefully and correctly since it may explode if it is scratched or shocked. If a lamp explodes, follow the instructions under "If a Lamp Explodes" on page [16](#).
- Do not remove screws unless specified.

■ Replacing the Lamp

1 Turn off the projector, disconnect the power plug from the AC outlet, and let the projector stand for at least 1 hour.

2 As shown in the figure, insert a flat-head screwdriver in the gap and remove the lamp cover by raising it.

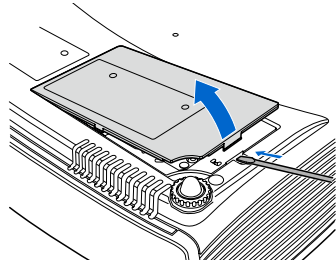

3 Loosen two screws with a philips-head screwdriver and then pull up the handle.

* Pull up the handle as shown in the figure.

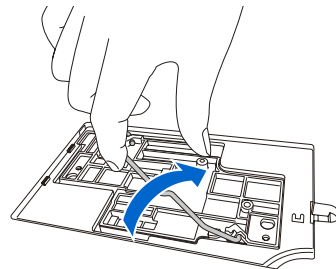

4 Remove the lamp while holding the center of the handle.

5 Fully insert a new lamp and secure it with two screws.

* After the installation, be sure to push down the handle.

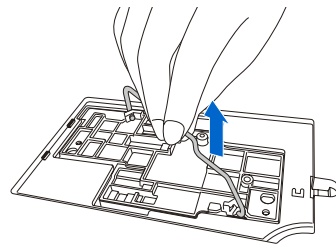

6 As shown in the figure, replace the lamp cover. Check whether the lamp cover is installed securely.

7 Turn on the projector.

8 Bring up the menu and select [System settings] -> [Other settings] -> [Lamp counter]. (P103)

9 Select [Reset] -> [OK] to reset the lamp counter.

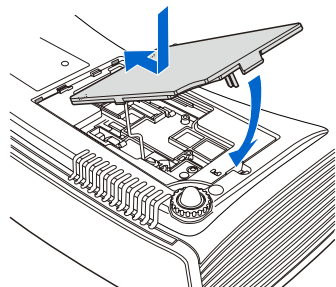

















Relationship between Aspect and Screen Aspect

This section describes the relationship between screen aspect (P60) and aspect (P63). To project an image on the whole screen, select the most appropriate screen aspect ratio and aspect according to the aspect ratio of the screen and input signal type.

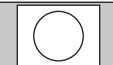
When Projecting an Image from a Computer

When the input signal is [ANALOG PC-1], [ANALOG PC-2], or [DIGITAL PC (SX80)], select screen aspect and aspect as follows according to the resolution of the image on the computer.

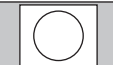
Screen	Screen Aspect Ratio Setting	Resolution of Computer Screen	Object of Projection	Aspect Setting
4:3	[4:3]	SXGA+  4:3	 Project an image in a largest possible size on the screen.	[Auto] (or [4:3])
		VGA, SVGA, XGA  4:3	 Project an image in a largest possible size on the screen.	[4:3]
			 Project the computer screen in the original resolution.	[True size]
		WXGA 	 Project an image in a largest possible size on the screen.	[Auto]
			 Project the computer screen in the original resolution. (WUXGA not selectable)	[True size]
		SXGA  5:4	 Project an image in a largest possible size on the screen.	[Auto]
			 Project the computer screen in the original resolution.	[True size]
		16:9	[16:9]	SXGA+  4:3
VGA, SVGA, XGA  4:3	 Project an image in a largest possible size on the screen.			[Auto]
	 Project the computer screen in the original resolution.			[True size]
WXGA 	 Project an image in a largest possible size on the screen.			[Auto]
SXGA  5:4	 Project an image in a largest possible size on the screen.			[Auto]

When Projecting an Image from Image Software

To project an image such as an image shot by a TV set, commercially available DVD software, or video camcorder (input signal [HDMI (SX80)], [VIDEO], [S-VIDEO (SX80)], [COMPONENT]), select an aspect ratio according to the image software format as follows.

Screen	Screen Aspect Ratio Setting	Image Software Format	Projection Result	Aspect Setting
4:3	[4:3]	4:3		[Auto] ^{*1}
		16:9		
16:9	[16:9] [16:9 D. image shift] ^{*4}	4:3		[Auto] ^{*2}
		16:9		
		4:3		[Zoom] ^{*3}

^{*1} [Auto] cannot be selected for the aspect setting if the input signal type is [VIDEO].

^{*2} If an image from image software with aspect ratio of 16:9 is not projected correctly, select [16:9] as screen aspect.

^{*3} If you project the 16:9 image with black borders at top and bottom such as in the terrestrial movie broadcasting, you can project the 16:9 image fully on the screen by selecting [Zoom] in [Aspect].





[Zoom] is available when [16:9] or [16:9 D. image shift] is selected for the screen aspect and [HDMI (480p)(SX80)], [COMPONENT (480p, 480i)], [VIDEO] or [S-VIDEO (SX80)] is selected for the input signal.

^{*4} To perform keystone adjustment (P58), select [4:3] or [16:9] for [Screen aspect].

When Projecting an Image from a Digital Camera or a USB Flash Memory (SX80)

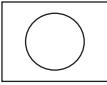
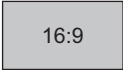
The [Auto] mode is automatically selected for the aspect ratio when displaying an image from a digital camera or USB flash memory (selecting [USB] as the input signal). The image is expanded fully on the screen with the screen aspect maintained.

Screen	Screen Aspect Ratio Setting	Projection Result	Aspect Setting
	[4:3]		[Auto]
	[16:9] [16:9 D. image shift]*		[Auto]

* To perform keystone adjustment (P58), select [16:9] for [Screen aspect].

Supported Computer Signal Types

This projector supports following signal types.

If your computer or AV equipment is compatible with any one of these signal types, the projector's auto PC function selects the input signal type to project an image appropriately.

ANALOG RGB

Signal type	Resolution (dots)	Horizontal frequency (KHz)	Vertical frequency (Hz)	
VGA	640 x 480	31.469	59.94	
		37.50	75.00	
		37.861	72.81	
		37.861	74.38	
		43.269	85.01	
	720 x 400	31.469	70.09	
		34.50	55.38	
SVGA	800 x 600	35.156	56.25	
		37.879	60.32	
		37.898	61.03	
		38.00	60.51	
		38.60	60.31	
		46.875	75.00	
		48.077	72.19	
		53.674	85.06	
		44.028	54.63	
		46.897	58.19	
XGA	1024 x 768	47.00	58.31	
		48.363	60.00	
		48.496	60.02	
		56.476	70.07	
		58.032	72.00	
		60.023	75.03	
		60.314	74.92	
		60.994	75.77	
		62.04	77.07	
		63.478	79.35	
		68.677	85.00	
		47.986	59.83	
		49.702	60.03	
		47.712	60.02	
WXGA	1280 x 768	64.196	70.39	
	1280 x 800	61.17	65.28	
SXGA	1152 x 864	61.846	66.00	
		71.399	75.64	
	1280 x 1024	1280 x 960	60.00	60.00
		62.50	58.63	
		63.337	59.98	
		63.364	59.95	
		63.735	60.01	
		63.791	60.18	
		63.899	60.00	
		63.981	60.02	
		71.694	67.19	
		76.97	72.00	
		79.976	75.03	
		81.135	76.11	
SXGA+	1400 x 1050	63.981	60.02	
UXGA	1600 x 1200	75.00	60.00	
MAC LC 13	640 x 480	34.967	66.60	
MAC13	640 x 480	35.00	66.67	
MAC16	832 x 624	49.725	74.55	
MAC19	1024 x 768	60.248	75.03	
MAC21	1152 x 870	68.681	75.06	
MAC	1280 x 960	75.00	75.08	

* The specifications in the table above are subject to change without notice.

* This projector does not support any computer signal of which dot clock is 170 MHz or higher.

DVI (SX80)

Signal type	Resolution (dots)	Horizontal frequency (KHz)	Vertical frequency (Hz)
D-VGA	640 x 480	31.469	59.94
D-SVGA	800 x 600	37.879	60.32
D-XGA	1024 x 768	48.363	60.00
D-SXGA	1280 x 1024	63.981	60.02
D-SXGA+	1400 x 1050	63.981	60.02

HDMI (SX80)

Signal type	Resolution (dots)	Horizontal frequency (KHz)	Vertical frequency (Hz)
480p	-	31.469	59.94
576p	-	31.250	50.00
720p	-	37.500	50.00
720p	-	44.955	59.94
1080i*	-	28.125	50.00
1080i*	-	33.716	59.94
1080p	-	56.250	50.00
1080p	-	67.433	59.94

* Interlaced signal

COMPONENT

Signal type	Resolution (dots)	Horizontal frequency (KHz)	Vertical frequency (Hz)
480p	-	31.469	59.94
480i*	-	15.734	59.94
576p	-	31.250	50.00
576i*	-	15.625	50.00
720p	-	37.500	50.00
720p	-	44.955	59.94
1035i*	-	33.750	60.00
1080i*	-	28.125	50.00
1080i*	-	33.716	59.94
1080p	-	56.250	50.00
1080p	-	67.433	59.94

* Interlaced signal

Relationship between Screen Size and Projecting Distance

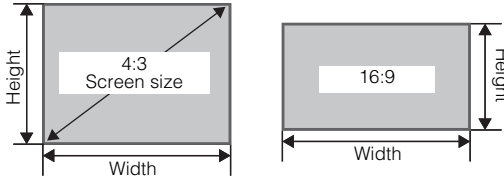

Screen size at 4:3 aspect ratio Type - W x D cm	Projecting distance m (feet) Max. zooming		Projecting distance m (feet) Min. zooming		Screen size at 16:9 aspect ratio W x D cm
	m	ft	m	ft	
40" (81 x 61)	1.2	(3.9')	1.7	(5.6')	81 x 46
50" (102 x 76)	1.5	(4.9')	2.2	(7.1')	102 x 57
60" (122 x 91)	1.8	(5.9')	2.6	(8.5')	122 x 69
70" (142 x 107)	2.1	(6.9')	3.1	(10.0')	142 x 80
80" (163 x 122)	2.4	(7.9')	3.5	(11.4')	163 x 91
90" (183 x 137)	2.7	(8.9')	4.0	(13.1')	183 x 103
100" (203 x 152)	3.0	(9.8')	4.4	(14.6')	203 x 114
110" (224 x 168)	3.3	(10.8')	4.9	(16.1')	224 x 126
120" (244 x 183)	3.6	(11.8')	5.3	(17.4')	244 x 137
130" (264 x 198)	3.9	(12.8')	5.8	(19.0')	264 x 149
140" (284 x 213)	4.2	(13.8')	6.2	(20.2')	284 x 160
150" (305 x 229)	4.5	(14.8')	6.6	(21.7')	305 x 171
160" (325 x 244)	4.8	(15.5')	7.1	(23.3')	325 x 183
170" (345 x 259)	5.1	(16.8')	7.5	(24.6')	345 x 194
180" (366 x 274)	5.4	(17.7')	8.0	(26.3')	366 x 206
190" (386 x 290)	5.7	(18.7')	8.4	(27.6')	386 x 217
200" (406 x 305)	6.0	(19.7')	8.9	(29.2')	406 x 229
210" (427 x 320)	6.4	(20.3')	-	-	427 x 240
220" (447 x 335)	6.7	(22.0')	-	-	447 x 251
230" (467 x 351)	7.0	(22.9')	-	-	467 x 263
240" (488 x 366)	7.3	(23.9')	-	-	488 x 274
250" (508 x 381)	7.6	(24.8')	-	-	508 x 286
260" (528 x 396)	7.9	(25.8')	-	-	528 x 297
270" (549 x 411)	8.2	(27.2')	-	-	549 x 309
280" (569 x 427)	8.5	(27.9')	-	-	569 x 320
290" (589 x 442)	8.8	(28.9')	-	-	589 x 331
300" (610 x 457)	9.1	(29.9')	-	-	610 x 343

* The values in the table above are approximations rounded off.

Glossary

* is only applicable to SX80

sRGB (P65, P89)

An international standard of color representation (color space) which is applied to general digital cameras, displays and others. In this projector, if you select [sRGB] in the [Image mode] setting, the projector can project the best-quality image conforming to the sRGB Standard.

DVI* (P40, P52)

A digital video signal connection interface for a computer. This interface allows digital data to be transmitted without converting to analog data, assuring high image quality with no signal degradation. The DVI-I (integrated) connector can be used to transmit both an analog video signal and digital video signal.

Digital PC* (P27, P40)

A signal system used to send digital information of individual display dots. This system is free from deterioration of image quality because of no analog conversion. Connect the DVI output terminal on the computer and ANALOG PC-1/DVI-I IN terminal on this projector with an optional DVI digital cable (LV-CA29). Select [DIGITAL PC] at projection.

Analog PC (P27, P38, P78)

A signal system used to send analog signal information of R (red), G (green), and B (blue). Connect the analog RGB output terminal on your computer to ANALOG PC-1/DVI-I IN terminal or ANALOG PC-2/COMPONENT IN terminal on the projector (in SX800, ANALOG PC-1 IN terminal or ANALOG PC-2/COMPONENT IN terminal), and select [ANALOG PC-1] or [ANALOG PC-2] at the time of projection.

HDMI* (P42, P52)

An abbreviation for High-Definition Multimedia Interface, which is a digital video signal connection interface for AV equipment. It can transmit non-compressed images and audio signals simultaneously. It supports digital contents copy-protected with the HDCP technology. The projector supports HDMI 1.3 standard (10-bit deep color).

HDCP*

An abbreviation of High-bandwidth Digital Content Protection which is an encryption technology for copy protection of digital image signals. In this projector, you can project digital contents copy-protected with the HDCP technology.

VIDEO (P27, P43, P78)

An output terminal widely used in an AV equipment. It is also called as a composite output terminal (pin terminal or RCA terminal). For more details, refer to "Composite".

Composite (P27, P43)

A video signal system used to send a brightness signal (Y) and a color signal (C) together. Connect the composite output (RCA) terminal on the AV equipment and the VIDEO IN terminal on this projector with a video cable. Select [VIDEO] at projection.

S-VIDEO* (P27, P43, P78)

A signal system (YC separation signal) used to send a brightness signal (Y) and color signal (C) separately. Connect the S-video terminal on the AV equipment and the S-VIDEO IN terminal on this projector with an S-video cable. Select [S-VIDEO] at projection.

Aspect (P63, P77, P135)

The aspect ratio is the ratio of the horizontal dimension (width) to the vertical dimension (height) of a screen. It is expressed as "width : height."

The following aspect ratios are normally used in Computer or AV equipment.

[4:3]

The aspect ratio for SXGA+ (1400 x 1050) and XGA (1024 x 768) display resolution in PC or for the traditional television screen. The aspect ratio for this projector is 4:3.

[5:4]

The aspect ratio for SXGA (1280 x 1024) display resolution.

[16:9]

The aspect ratio for the high resolution digital television or digital terrestrial broadcasting.

For the aspect ratio for movie screens, "vista vision size" and "cinema scope size", etc. are used.

"Vista vision size"

The aspect ratio close to 16:9. Select [Auto] or [16:9] for [Aspect]. The back belts are added at the top and bottom of the image.

"Cinema scope size"

The landscape-oriented aspect ratio of 8:3. Select [Auto] or [16:9] for [Aspect]. The back belts are added at the top and bottom of the image.

Component (P27, P44, P92)

A signal system used to send a color signal (C) with it divided into a B-Y color difference signal and an R-Y color difference signal. This system can project a better-quality image as compared with the composite signal system. Connect the component video terminal on the AV equipment and the ANALOG PC-2/COMPONENT IN terminal on this projector with a component cable. Select [COMPONENT] at projection.

Tracking (P55, P80)

To reproduce an image from an analog image signal, the process to accumulate image information at the appropriate timing with reference to the synchronization signal within the image signal is required. This process is called the tracking. This projector can display an image properly by automatically adjust the tracking with the auto PC adjustment function even if there is a small difference in the synchronization signal from an analog imaging device.

Resolution (P54)

The number of dots (horizontal dots x vertical dots) that can be displayed on the screen. It describes the fineness (information amount) of the displayed image.

Resolution	Number of dots	
	Horizontal	Vertical
VGA	640	480
SVGA	800	600
XGA	1024	768
SXGA	1280	1024
SXGA+	1400	1050
UXGA	1600	1200

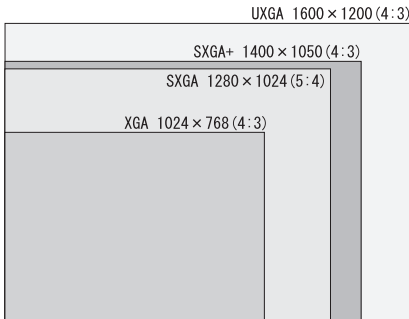

Number of dots in each resolution

If you select SXGA+ (1400 dots x 1050 dots) as the display resolution for the connecting computer, this projector can project high-resolution images. If your computer does not have the SXGA+ option, select the maximum resolution among the selectable options.

Progressive (P83)

An image display system used to display the entire screen per scan. For an interlace signal (video signal) that displays one screen by two scans (one for odd lines and one for even lines) is input, progressive processing is required. When the progressive function is turned off, one screen is displayed using image signals per interlace signal, deteriorating the vertical resolution of the image. When the progressive function is turned on, one screen is displayed using image signals per two interlace signals, improving the vertical resolution of the image. Turn off the progressive function when flickering and horizontal lines are noticeable on a fast-moving picture.

Offset (P92)

A parameter that shifts the reproduction range of a brightness signal from black to white within an image signal toward the higher or lower level of brightness. The reproducibility of the dark tone is mainly changed. Since you can adjust the offset for each RGB color in this projector, you can also adjust colors.

The offset is normally adjusted with the gain.

Gamma Correction (P91, P93)

A tone adjustment system used during projection of image data. The gamma correction function works effectively when portions of an image are obscure because they are too light or dark.

This projector supports manual gamma correction and dynamic gamma correction which performs the gamma correction automatically.

Gain (P92)

A parameter that adjusts the reproduction range of a brightness signal from black to white within the image signal to naturally reproduce it on the screen. The reproducibility of the bright tone is mainly changed. Since you can adjust the gain for each RGB color in this projector, you can also adjust colors. The gain is normally adjusted with the offset.

Memorized Color Correction * (P94)

A memorized color is a color in our memory. The memorized color such as blue for the sky is more vivid than the real color, so you may feel colors of a projected image are dull. If such is the case, enable the memorized color correction function to make the colors close to the ones in our memory. You can enable the memorized color correction function in the image adjustment menu.

6-axis color adjust* (P95)

The color adjustment function for an advanced user. You can adjust color balance and color level for 6 axis of RGB (red/green/blue) and CMY (cyan/magenta/yellow) of the projected image to make a fine color adjustment. You can perform the 6-axis color adjustment in the image adjustment menu.

PictBridge* (P108)

A standard protocol established by CIPA (Camera & Imaging Products Association) that supports various digital photo solutions including camera direct print to print shot images by directly connecting a digital camera to a printer without via a computer. Other than digital cameras, some digital video camcorders and mobile phones are compatible with PictBridge. In this projector, you can project shot images by directly connecting PictBridge-compatible equipment.

DPOF* (P109)

An abbreviation of Digital Print Order Format. It is a protocol to record information specified for printing such as images to be printed and the number of copies on a memory card for PictBridge-compatible digital camera. In this projector, use this function to continuously project multiple shot images from a connected digital camera.

Specifications

■ Projector

Model name		SX80/SX800
Display system		RGB liquid crystal system
Optical system		Color separation by dichroic mirror/polarizing beam splitter and color composition by prism
Display device	Type	Reflective liquid crystal panel
	Size/Aspect ratio	0.55" x 3/4:3
	Drive system	Active matrix system
Number of pixels/Total Number of pixels		1,470,000 (1400 x 1050) x 3 panels/4,410,000
Zoom ratio/Focal length/F value		1.5f=16.6 to 24.8mm/F1.95 to F2.6
Projection lens	Zooming and focusing system	Electronic operation/electronic operation (SX80: with auto focusing function)
	Lens shift	10:0 (fixed)
Light source		230W high-pressure lamp
Screen size (projection distance)		40" to 300" (1.2m/3.9' to 9.1m/12.8')
Number of producible colors		16,770,000 colors (full color)
Brightness*		3,000 lm (at presentation)
Contrast ratio		900:1 (full white:full black, at presentation)
Uniformity*		88% (at presentation)
Speaker		1W monaural x 1
Maximum input resolution		1600 x 1200 dots (compression)
Video signals	ANALOG PC input	UXGA/SXGA+/SXGA/WXGA/XGA/SVGA/VGA (scan rate: horizontal: 15 to 75KHz, vertical 50 to 85Hz)
	DIGITAL PC input (SX80)	SXGA+/SXGA/XGA/SVGA/VGA
	COMPONENT input	1080p, 1080i, 1035i, 720p, 576p, 576i, 480p, 480i
	HDMI input (SX80)	1080p, 1080i, 720p, 576p, 480p
	VIDEO/S-VIDEO (SX80) input	NTSC, PAL, SECAM, NTSC4.43, PAL-M, PAL-N
Input terminals	ANALOG PC-1/DVI-I IN terminal (SX80)	DIGITAL PC, ANALOG PC-1 (DVI-I connector 29-pin)
	HDMI IN terminal (SX80)	HDMI (HDMI ver. 1.3)
	ANALOG PC-1 terminal (SX800)	ANALOG PC-1 (mini D-sub 15-pin)
	ANALOG PC-2/COMPONENT IN terminal	ANALOG PC-2, COMPONENT (mini D-sub 15-pin)
	S-VIDEO IN terminal (SX80)	S-Video (mini DIN 4-pin)
	VIDEO IN terminal	Composite (RCA)
	USB terminal (SX80)	USB connection, PictBridge input (USB type A)
	CONTROL terminal	RS-232C (D-sub 9-pin)
Audio Input terminal		Audio signal (stereo mini jack x 3)
Video Output terminal (SX80)		Analog PC (mini D-sub 15-pin)
Audio Output terminal		Audio signal (stereo mini jack)
LAN terminal (SX80)		Network connection (RJ-45)
Input signals	Digital PC (SX80)	TMDS (Transition Minimized Differential Signaling)
	Analog PC	0.7Vp-p, positive polarity, impedance = 75Ω Horizontal/vertical synchronization: TTL level, negative or positive polarity Composite synchronization in G signal: 0.3Vp-p, negative polarity, impedance=75Ω
	Video	Video: 1Vp-p, negative synchronization, impedance = 75Ω S-video: Separate YC signal, Y: 1Vp-p, negative synchronization, impedance = 75Ω C: 0.286Vp-p (burst signal), impedance = 75Ω Component: Separate Y Cb/Pb Cr/Pr signal Y: 1Vp-p, Negative synchronization, impedance = 75Ω Cb/Pb: 0.7Vp-p, impedance = 75Ω Cr/Pr: 0.7Vp-p, impedance = 75Ω
	Audio	142mVrms, impedance = 47 KΩ or more
Noise (normal mode/silent mode)		35/31dB
Operating temperature		5 °C to 35 °C
Power supply		AC 100-240 V 50/60 Hz
Power consumption (normal mode/silent mode/standby state)		330W/270W/15W (SX80) 320W/260W/8W (SX800)
Dimensions		332 (W) x 121 (H) x 340 (D) mm/13.3 (W) x 4.8 (H) x 13.6 (D) in (excluding protrusions)
Weight		5.2 kg/11.4 lbs (SX80) 5.0 kg/11.0 lbs (SX800)
Accessories		Remote control, batteries for remote control, power cord, computer connection cable, component cable, carrying bag, lens cover, string for lens cover, User's Manual, and Warranty Card.

* 99.99% or more of the LCD panel pixels are effective. During projection, 0.01% or less of pixels may stay lit or unlit due to the characteristics of the LCD panel.

* Using the projector continuously for an extended period of time may accelerate the deterioration of optical parts.

■ Remote Control

Power supply	Two 3.0 V, AAA-size batteries
Operating range	About 5 m (16.4') (to infrared remote receiver)
Dimensions	42 (W) x 22 (H) x 135 (D) mm / 1.7 (W) x 0.9 (H) x 5.3 (D) in
Weight (not including batteries)	55 g

External View

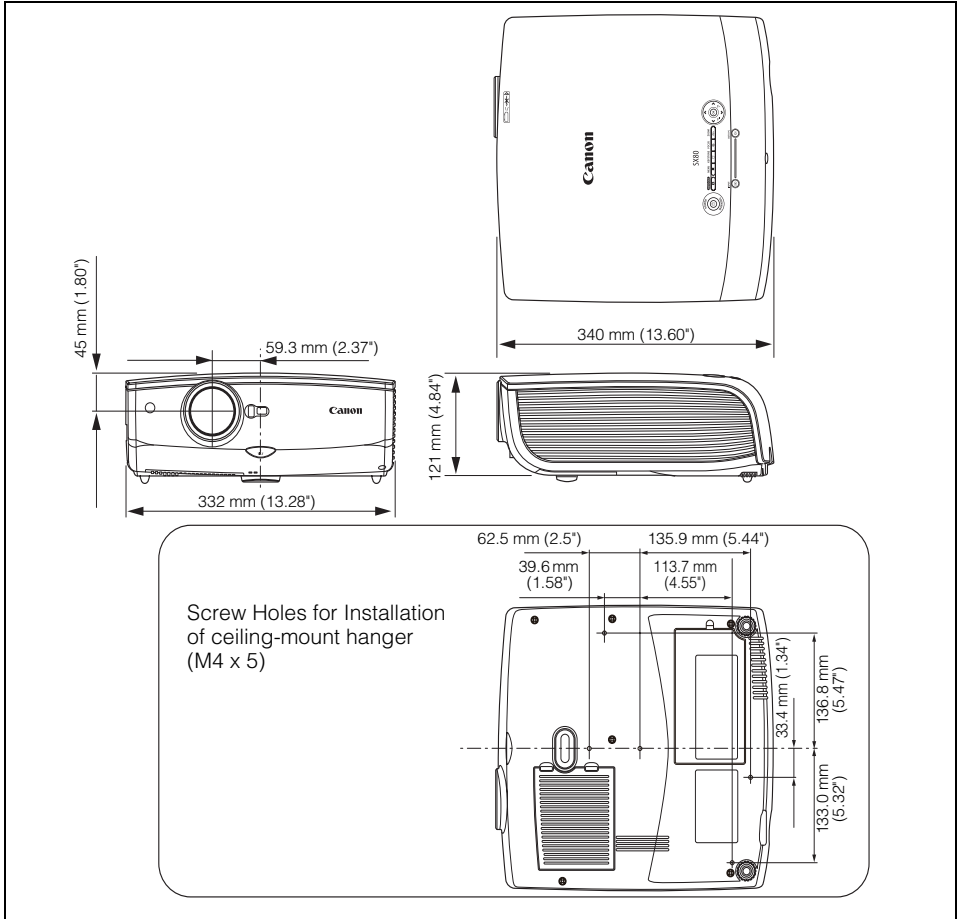

ANALOG PC-1 (SX800), ANALOG PC-2/COMPONENT IN terminal

This terminal is used as a computer analog PC input or component input terminal. Use a D-sub computer cable for connection.

The terminal specifications for the analog PC input and component input are the same.

Mini D-sub 15-pin

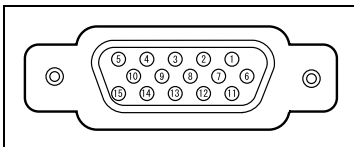

1	R	9	+5 V power
2	G	10	Ground (Vertical sync.)
3	B	11	Monitor ID0
4	Monitor ID2	12	DDC data
5	Ground (Horizontal sync.)	13	Horizontal sync.
6	Ground (R)	14	Vertical sync.
7	Ground (G)	15	DDC clock
8	Ground (B)		

■ Service Port (CONTROL)

D-sub 9pin

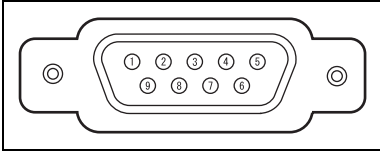

Pin No.	Signal
1	OPEN
2	RxD
3	TxD
4	OPEN
5	GND
6	OPEN
7	OPEN
8	OPEN
9	OPEN

Communication format

Communication mode: RS-232-C, asynchronous,
half-duplex communication

Communication speed: 19,200 bps

Character length: 8 bits

Stop bits: 2 bits

Parity: None

Flow control: None

Control Commands

Function	ASCII Representation	Binary Representation
Power supply	On	POWER ON<CR>
	Off	POWER OFF<CR>
	Get	GET POWER<CR>
Input signals	Digital PC (SX80)	INPUT=D-RGB<CR>
	HDMI (SX80)	INPUT=HDMI<CR>
	Analog PC-1	INPUT=A-RGB1<CR>
	Analog PC-2	INPUT=A-RGB2<CR>
	Component	INPUT=COMP<CR>
	Video	INPUT=VIDEO<CR>
	S-Video (SX80)	INPUT=S-VIDEO<CR>
	USB (SX80)	INPUT=USB<CR>
	Get	GET INPUT<CR>
Image mode	Standard	IMAGE=STANDARD<CR>
	Presentation	IMAGE=PRESENTATION<CR>
	sRGB	IMAGE=SRGB<CR>
	Movie	IMAGE=MOVIE<CR>
Brightness	Setting	BRI=<value><CR>
	Get	GET BRI<CR>
Sharpness	Setting	SHARP=<value><CR>
	Get	GET SHARP<CR>
Contrast	Setting	CONT=<value><CR>
	Get	GET CONT<CR>
Aspect ratio	Auto	ASPECT=AUTO<CR>
	4:3	ASPECT=4:3<CR>
	16:9	ASPECT=16:9<CR>
	Zoom	ASPECT=ZOOM<CR>
	True size	ASPECT=TRUE<CR>
Lamp mode	Normal	LAMP=NORMAL<CR>
	Quiet	LAMP=SILENT<CR>
	Get	GET LAMP<CR>
BLANK	Blank On	BLANK=ON<CR>
	Blank Off	BLANK=OFF<CR>
	Get	GET BLANK<CR>

Numerics

6-axis color adjust (SX80)95, 143

A

Adjustable foot35

Adjusting keystone distortion58

Adjusting the focus57

Adjusting the volume69

Air filter132

ANALOG PC38, 52

Analog PC140

ANALOG PC-1 Input Terminal
(SX800)27, 38, 52

ANALOG PC-1/DVI-I IN terminal
(SX80)27, 38, 40, 52

ANALOG PC-2/COMPONENT
IN terminal27, 39, 44, 52

ASPECT64

Aspect60, 63, 77, 135, 141

Audio IN terminal28, 38, 39, 40, 43, 44

Audio OUT terminal28, 41, 45

Auto (Aspect)63

Auto fleshtone (SX800)94

Auto focus (SX80)50, 97

Auto input50, 97

Auto keystone50, 97

AUTO PC55

Auto screen color (SX80)50, 97

AUTO SET51

Auto setup50, 97

B

Beep98

BLANK68

Brightness90

C

Carrying bag17, 21

Ceiling mounted34, 85

Channel setting101

Color adjustment92

COMPONENT44, 52

Component141

Composite140

Connecting the projector to the
computer38

Contrast90

D

D. ZOOM70

D.SHIFT/KEYSTONE58, 62

Digital camera (SX80)108

DIGITAL PC (SX80)40, 52

Digital PC (SX80)140

Direct power on98

Display resolution (preparing the
computer)54

Display settings menu74

Displays logo88

DPOF (SX80)109, 143

DVI (SX80)140

DVI-I IN (SX80)38, 40, 52

Dynamic gamma93

E

External monitor (SX80)40

F

Factory defaults105

FOCUS57

FREEZE68

G

Gain92, 142

Gamma correction91, 142

Guide100

H

HDCP140

HDMI (SX80)42, 52, 140

HDMI IN terminal (SX80)27, 42

HDMI input level (SX80)82

HDMI over scan (SX80)83

Horizontal pixels81

Horizontal position80

- I**
- IMAGE 65
 - Image adjustment menu 74
 - Image flip H/V 85
 - Image mode 89
 - Image mode (Image quality) 65
 - Information 74, 106
 - INPUT 53
 - Input signal select 78, 79
 - Input terminal 27
 - Connecting the projector to the
 - computer 38
 - Connecting to AV equipment 42
 - Installation 17
 - IP address (SX80) 120
- K**
- Key lock 99
 - Keystone 58
- L**
- LAMP 95
 - Lamp counter 103
 - Lamp mode 95
 - Lamp replacement 103, 133, 134
 - LAN port (SX80) 28, 120
 - Language 99
 - LED illumination 100
 - Lens cap 20
 - Logo capture 86
 - Logo position 86
- M**
- Mem. color correct (SX80) 94
 - Memorized color correction (SX80) 142
 - MENU 74
 - Menu display time 102
 - Menu position 84
 - Monitor output terminal (SX80) 27, 40
 - MUTE 69
- N**
- Network settings (SX80) 105, 120
 - Noise reduction 93
- O**
- Offset 92, 142
 - OK 25
- P**
- Password settings 102
 - PictBridge (SX80) 108, 143
 - POWER 47, 66, 98
 - Power management 48
 - Power management mode (settings) 97
 - Power saving (power management) 48
 - Progressive 83, 142
 - Projecting distance 33, 139
 - Projector on 88
 - P-TIMER 71
- R**
- Rear projection 34, 85
 - Register password 103
 - Remote control 24, 29, 101
 - Reset 96, 105
 - Resolution 63, 141
 - Reverse projection (ceiling-mounted/
rear projection) 85
- S**
- Screen aspect 60, 88, 135
 - Screen color 84
 - Screen size 139
 - Screen when blank 87
 - Selecting a language 48, 99
 - Selecting an input signal 52
 - Setting Display Status 77
 - Setting the Image Quality 89
 - Setting up the projector 17, 33
 - Setting Various Function 97
 - Sharpness 91
 - Signal type 138
 - Slideshow (SX80) 101, 111, 118
 - sRGB 65, 89, 140
 - S-VIDEO (SX80) 43, 52, 140

S-VIDEO input terminal (SX80)27, 43
System settings menu 74

T

Top control26
Total dots 79
Tracking80, 141
True size (Aspect) 63
Turning on external monitor output
(preparing the notebook
computer) 49

U

USB (SX80)52, 112
USB terminal (SX80)27, 52, 108, 112

V

Vertical pixels 82
Vertical position 81
VIDEO 43, 52, 140
VIDEO IN terminal27, 43
VOL 69

W

WARNING lamp26, 126

Z

ZOOM 56
Zoom (Aspect) 63
Zoom (image size) 56
Zooming an Image 70

Options

- Replacement lamp
Part No.: RS-LP05
- Ceiling-mount hanger
Part No.: RS-CL10
- Ceiling-mount pipe
(40 cm/16 in to 60 cm/24 in)
Part No.: RS-CL08*
- Ceiling-mount pipe
(60 cm/24 in to 100 cm/40 in)
Part No.: RS-CL09*
- DVI digital cable
Part No.: LV-CA29

* This part is used to hang the projector from a ceiling.
For more detailed information, refer to the instruction manual that comes with the ceiling-mount hanger RS-CL10.

Menu Configuration

The Display settings menu

Aspect	DIGITAL PC (SX80)/ ANALOG PC	P77
	Auto *	
	4:3	
	16:9	
	True size	
	VIDEO	
	4:3 *	
	16:9	
	Zoom	
	S-VIDEO (SX80)	
	Auto *	
	4:3	
	16:9	
	Zoom	
	HDMI (SX80)	
	Auto *	
	4:3	
	16:9	
	Zoom	
	True size	
	COMPONENT	
	Auto *	
	4:3	
	16:9	
	Zoom	
	True size	
	USB (SX80)	
	Auto	
Input signal select	ANALOG PC	P78
	640 x 480	
	:	
	1400 x 1050	
	VIDEO/S-VIDEO (SX80)	P78
	Auto *	
	NTSC	
	PAL	
	SECAM	
	NTSC4.43	
	PAL-M	
	PAL-N	
	COMPONENT	P79
	Auto *	
	1080p	
	1080i	
	1035i	
	720p	
	576p	
	480p	
	576i	
	480i	

Input signal settings	ANALOG PC	
	Total dots	P79
	Tracking	P80
	Horizontal position	P80
	Vertical position	P81
	Horizontal pixels	P81
	Vertical pixels	P82
HDMI input level (SX80)	HDMI	P82
	Auto *	
	Normal	
	Expanded	
HDMI over scan (SX80)	HDMI	P83
	Off	
	On *	
Progressive	VIDEO/S-VIDEO (SX80)/ COMPONENT/HDMI (SX80)	P83
	Off	
	On	
	Auto *	
Menu position		P84
Screen color	Normal *	P84
	Greenboard	
	Adjust Red/Green/Blue	
Image flip H/V	None *	P85
	Ceiling mounted	
	Rear	
	Rear, Ceiling mounted	
User screen settings		
Logo capture	OK/Cancel	P86
Logo position	Upper L	P86
	Upper R	
	Center *	
	Lower L	
	Lower R	
No signal screen	Black	P87
	Blue *	
	User logo	
Screen when blank	Black *	P87
	Blue	
	User logo	
Projector on	Skip	P88
	Canon logo *	
	User logo	
Return		
Screen aspect	4:3 *	P88
	16:9	
	16:9 D. image shift	

*: Factory defaults (setting after reset)

[DIGITAL PC], [HDMI], [USB], and [S-VIDEO] are supported only in SX80.

The Image adjustment menu

Image mode	Standard *	P89
	Presentation	
	Movie	
	sRGB	

Brightness	P90
Contrast	P90
Sharpness	P91
Gamma	P91

Color adjustment	
VIDEO/S-VIDEO (SX80)/COMPONENT	P92
Color level	
Color balance (only for COMPONENT)	
COMMON	P92
R Gain	
R Offset	
G Gain	
G Offset	
B Gain	
B Offset	

Advanced adjustment		
Noise reduction	VIDEO/S-VIDEO (SX80)/ COMPONENT/HDMI (SX80)	P93
	Off	
	Weak	
	Strong	

Dynamic gamma	Off	P93
	Weak	
	Strong	

Mem. color correct (SX80)	Off	P94
	L	
	M	
	H	

Auto fleshtone (SX800)	Off	P94
	L	
	M	
	H	

6-axis color adjust (SX80)	Off *	P95
	Adjust Hue/Saturation	
	Reset	

Return

Lamp mode	Normal *	P95
	Quiet	

Reset	OK/Cancel	P96
-------	-----------	-----

The Information menu

Model name	P106
Input signal	
Firmware	
Serial no.	
IP address (SX80)	
Gateway address (SX80)	
E-mail sender address (SX80)	
E-mail recipient address (SX80)	
Projector name (SX80)	
System information ID	

The System settings menu

Auto setup	P97
Auto focus (SX80)	Off
	On *
Auto keystone	Off
	On *
Auto input	Off
	On *
Auto screen color (SX80)	Off *
	On
Return	

Power management mode	Off *	P97
	Standby	
	Exit	

Direct power on	Off *	P98
	On	

Beep	Off	P98
	On *	

Key lock	Off *	P99
	Main unit	
	Remote control	

Language	English	Polish	P99
	Germany	Hungarian	
	French	Czech	
	Italian	Danish	
	Spanish	Arabic	
	Portuguese	Chinese (Simplified)	
	Swedish	Russian	
	Dutch	Chinese (Traditional)	
	Finnish	Korean	
	Norwegian	Japanese	
	Turkish		

Guide	Off	P100
	On *	

LED illumination	Off	P100
	On *	

Slideshow interval (SX80)	--:--	P101
---------------------------	-------	------

Other settings		
Remote control	Ch1 *	P101
	Ch2	
Menu display time	Normal *	P102
	Extended	
Password settings	Off *	P102
	On	
Register password	Password input	P103
Lamp counter	Return	P103
	Reset	
	OK/Cancel	
Network setting Initialization (SX80)	YES/NO	P105
Factory defaults	OK/Cancel	P105
Return		

**CANON INC.**

30-2, Shimomaruko 3-chome, Ohta-ku, Tokyo
146-8501, Japan

U.S.A.

CANON U.S.A. INC.

One Canon Plaza, Lake Success, NY 11042-
1198, U.S.A.

For all inquiries concerning this product, call toll
free in the U.S.
1-800-OK-CANON

CANADA

CANON CANADA INC. HEADQUARTERS

6390 Dixie Road, Mississauga, Ontario L5T
1P7, Canada

CANON CANADA INC. MONTREAL BRANCH

5990, Côte-de-Liesse, Montréal Québec H4T
1V7, Canada

CANON CANADA INC. CALGARY OFFICE

2828, 16th Street, N.E. Calgary, Alberta T2E
7K7, Canada

For all inquiries concerning this product, call toll
free in Canada
1-800-OK-CANON

EUROPE, AFRICA & MIDDLE EAST

CANON EUROPA N.V.

Bovenkerkerweg 59-61, 1185 XB Amstelveen,
The Netherlands

CANON FRANCE S.A.S

17, quai du President Paul Doumer, 92414
Courbevoie Cedex, France

CANON UK LTD.

Woodhatch Reigate Surrey RH2 8BF, United
Kingdom

CANON DEUTSCHLAND GmbH

Europark Fichtenhain A10, 47807 Krefeld, Ger-
many

CANON ITALIA S.p.A.

Via Milano 8 I-20097 San Donato Milanese, Mil-
ano, Italy

CANON Schweiz AG

Geschäftsbereich Wiederverkauf, Industri-
strasse 12, CH-8305 Dietlikon,
Switzerland

CANON GMBH

Zetschegasse 11, A-1230 Wien, Austria

CANON España, S.A.

C/Joaquín Costa, 41, 28002 Madrid, Spain

CANON PORTUGAL S.A.

Rua Alfredo da Silva, 14 Alfragide 2610-016
Amadora, Portugal

CANON Belgium N.V./S.A.

Berkenlaan 3, 1831 Diegem (Mechelen), Bel-
gium

CANON Netherland NV

Neptunusstraat 1, 2132 JA Hoofddorp, The
Netherlands

CANON LUXEMBOURG S.A.

Rue des Joncs 21, L-1818 Howald, Luxem-
bourg

CANON DANMARK A/S

Knud Hoejgaards Vej 1 DK-2860 Soeborg, Dan-
mark

CANON OY

Huopalahdentie 24 PL 1 00351 Helsinki, Fin-
land

CANON SVENSKA AB

Gustav III:s Boulevard 26 169 88 Solna, Swe-
den

CANON NORGE as

Hallagerbakken 110, Postboks 33, Holmlia,
1201 Oslo, Norway

CENTRAL & SOUTH AMERICA

CANON LATIN AMERICA, INC.

703 Waterford Way, Ste. 400 Miami, FL 33126,
U.S.A.

ASIA

CANON (China) Co., Ltd.

15F Jinbao Building No.89 Jinbao Street,
Dongcheng District, Beijing 100005, China

CANON HONGKONG CO., LTD.

19/F., The Metropolis Tower, 10 Metropolis
Drive, Hunghom, Kowloon, Hong Kong

CANON SINGAPORE PTE. LTD.

1 HarbourFront Avenue, #04-01 Keppel Bay
Tower, Singapore 098632

CANON KOREA CONSUMER IMAGING INC.

Gangnam Finance Center 17F,737, Yeoksam-
Dong, Gangnam-gu, Seoul, 135-984, Korea

OCEANIA

CANON AUSTRALIA PTY. LTD.

1 Thomas Holt Drive, North Ryde, N.S.W. 2113,
Australia

CANON NEW ZEALAND LTD.

Akoranga Business Park, Akoranga Drive,
Northcote, Auckland, New Zealand